

FLUKE®

Fluke 1750 Three-Phase Power Recorder

Technical Data

Never miss capturing a disturbance - with the exclusive threshold-free measurement system, it's automatic

Capture every measurement, every event, on every cycle, all the time with the Fluke 1750 Power Recorder. Unprecedented accuracy and resolution provide complete visibility into your distribution system.



• **Premium accuracy and measurement techniques:**

- Guaranteed for all power quality parameters, with IEC 61000-4-30 Class A measurement systems
- Quick and reliable configuration:** PDA wireless "front panel interface" provides a window into what the instrument is recording, even in awkward test locations
- Threshold-free setup:** Apply thresholds after data is collected with Fluke Power Analyze Software
- Captures everything:** Cross-channel and current triggering capture every measurement, on every channel, every time
- Intuitive PC software:** Easily analyze data and generate reports

- Plug and play:** Set up in minutes with self-identifying current probes and single-lead voltage connections
- No need to reconnect wires:** Swap channels internally with the wireless PDA or PC when connections are not correct
- Measure every parameter:** voltage and current on three phases, neutral, and ground
- 5 MHz, 8000 Vpk waveform capture:** Get a detailed picture of even the shortest events
- Quickly retrieve data:** With included SD memory card or via the 100BaseT high-speed Ethernet connection



宇宏企業股份有限公司 RADIOTEK CORPORATION

台北縣三重市重新路五段609巷16號6樓之1

TEL: 02-22782269 FAX: 02-22782059

Home page : www.radiotek.com.tw

E-mail : salesmag1@rdlmail.com.tw



Applications

Long-term analysis: Uncover hard-to-find or intermittent issues

Power quality surveys: Quantify power quality throughout a facility, documenting results with professional reports

Quality of service compliance: Validate incoming power quality at the service entrance

Semi-permanent monitoring: Monitor critical equipment, capturing power quality events to correlate with equipment malfunction

Easy to use

The recorder automatically detects, scales, and powers current probes without needing batteries. Requiring only single-lead voltage connections enables safe and quick setups. Once power is applied the instrument automatically begins recording and LEDs give you assurance that the recorder is powered up and signals are within range – no more uncertainty that data is being recorded. The Fluke 1750 has an exclusive capture algorithm which makes certain all events are captured without the tedious setups and blind spots associated with threshold driven equipment.

The PDA wirelessly interfaces with the recorder, allowing quick setup and verification with waveform displays, meter screens, and phasor diagrams. The built-in wireless technology allows you to control multiple instruments from a distance easily, without the need for a laptop computer (laptops can also be used when desired).

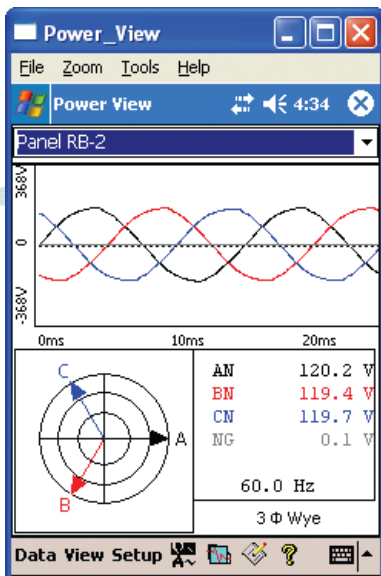

View measurements real-time with wireless PDA interface.

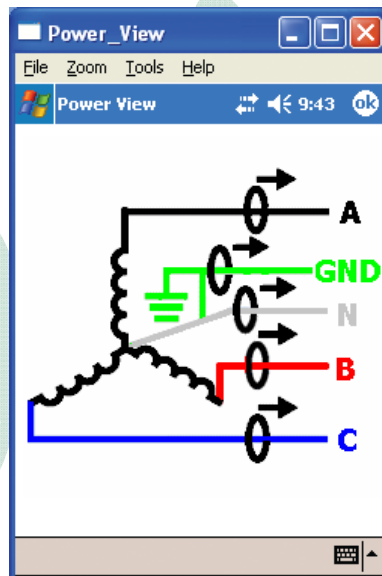

Configurations are simple with wiring diagrams to guide you.

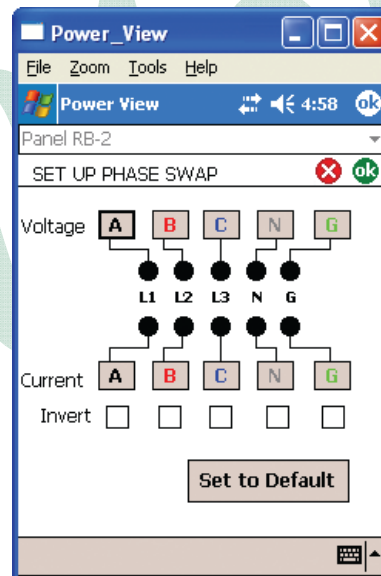

No need to reconnect wires—swap channels internally using the PDA interface.



宇宏企業股份有限公司 RADIOTEK CORPORATION

台北縣三重市重新路五段609巷16號6樓之1

TEL: 02-22782269 FAX: 02-22782059

Home page : www.radiotek.com.tw

E-mail : salesmag1@rdtmail.com.tw

Comprehensive power system data

Every cycle on every channel is simultaneously sampled providing complete analysis of power quality, harmonics, power and energy. Cross-channel current and voltage triggering captures event data on all input channels simultaneously, no matter which channel triggered the event. When periodic analysis of the waveform may be needed, the Snapshot mode captures waveforms at user-defined intervals. Even dc signals can be recorded!

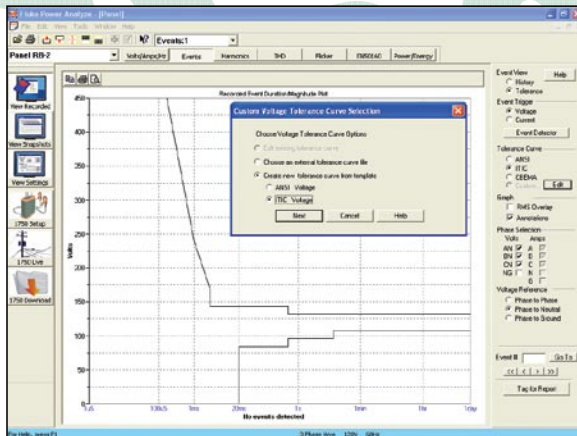

Events can be displayed against a variety of tolerance curves.

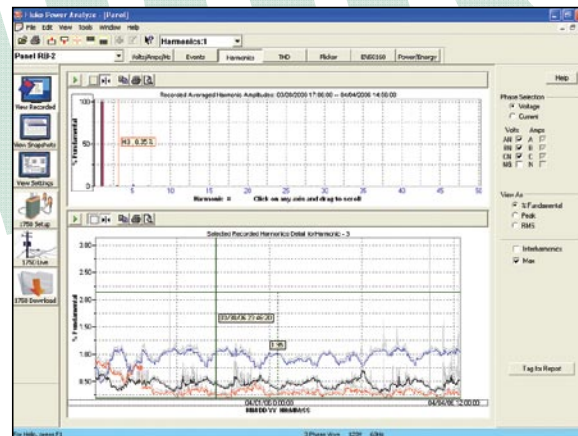

Full FFT on each channel to the 50th harmonic.

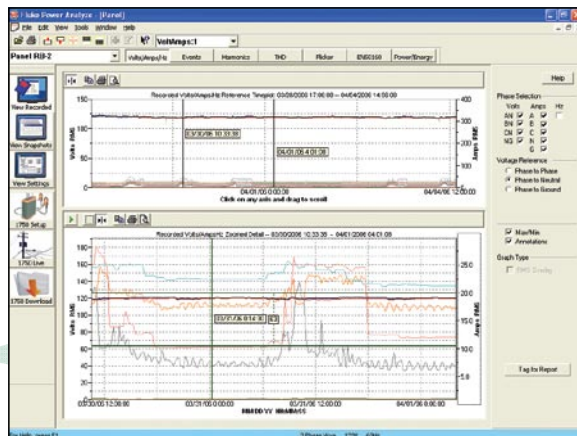

Display multiple parameters simultaneously on one graph.

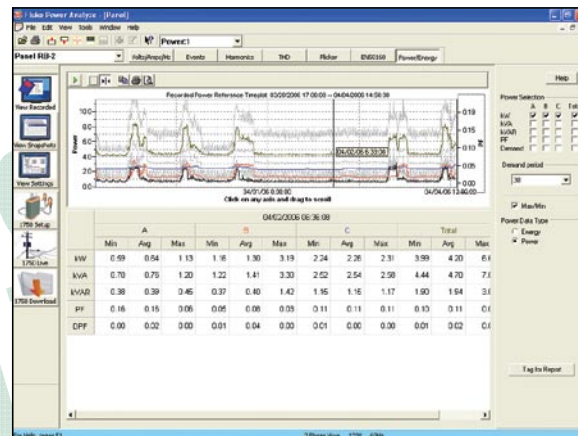

Full-featured power meter display for each channel and totals.

Powerful data management

Data is automatically stored on the internal flash memory that can store records for over a month without compression or overwriting. Data is retrieved via one of two quick and easy options: download the data onto the included SD memory card without using your laptop, or transfer directly to your computer via Ethernet, using TCP/IP protocol.

Voice, data, and picture annotations can be made via the PDA to flag important points in the data stream. Imagine being able to flag in your recorded data when a transfer switch was operated, or load changes were made.



宇宏企業股份有限公司 RADIOTEK CORPORATION

台北縣三重市重新路五段609巷16號6樓之1

TEL: 02-22782269 FAX: 02-22782059

Home page : www.radiotek.com.tw

E-mail : salesmag1@rdtmail.com.tw

View data the way you want

The new Fluke Power Analyze software revolutionizes your ability to analyze data. No need to worry about thresholds – with Fluke Power Analyze, thresholds can be modified after the data is recorded! And the easy-to-use user interface will display voltage as a phase-to-phase or phase-to-neutral reading.

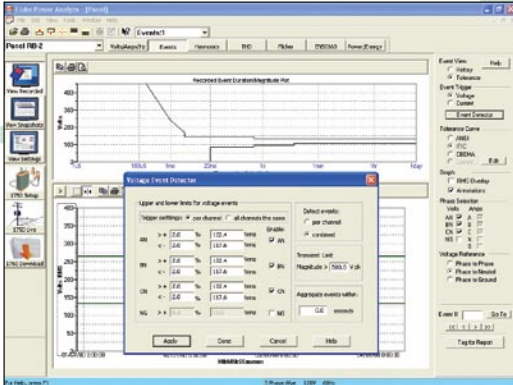

Apply thresholds to data after collection using a variety of standard or customized templates.

All the latest power quality standards are built-in

IEC 61000-4-30 Class A measurement systems provide the confidence that all parameters are measured and calculated consistently with international standards.

600 V CAT IV and 1000 V CAT III safety rating

Designed to help protect you and your equipment, the Fluke 1750 Three-Phase Power Recorder and accessories are all certified to meet the stringent safety standards for use in 600 V CAT IV and 1000 V CAT III environments. They are the first tools of their kind to carry the CAT IV rating and, therefore, can be used for most power connections and for all outlets in a low-voltage power distribution system.

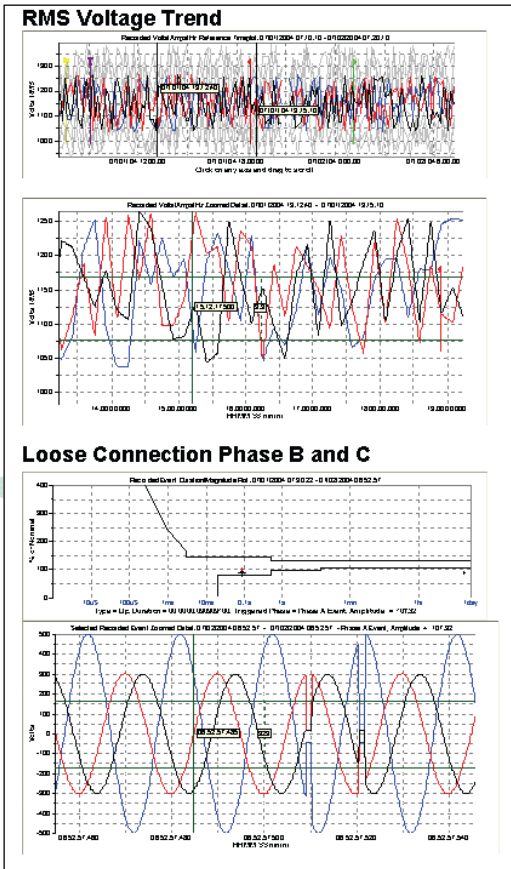

Simplified report writer feature included in Fluke Power Analyze.



宇宏企業股份有限公司 RADIOTEK CORPORATION

台北縣三重市重新路五段609巷16號6樓之1

TEL: 02-22782269 FAX: 02-22782059

Home page : www.radiotek.com.tw

E-mail : salesmag1@rdtmail.com.tw

Optional Accessories

Fluke Power Quality Current Transformers are specially designed to work seamlessly with Fluke Power Quality/RPM Full Disclosure™ Power Monitors. All Clamp-on and Flexi-CT's are matched to take full advantage of your instrument's ability to set scale factors for accurate readings.



Model No.	CT Type	Current Range	Accuracy	Frequency Response	Jaw Opening
3005R	Clamp-On	0.01 A to 5 A	1 % RDG ± 0.5 % FS	5 kHz	2 cm (.78 in) dia.
3014	Clamp-On	0.1 A to 40 A	1 % RDG ± 0.1 % FS	5 kHz	2 cm (.78 in) dia.
3120R	Clamp-On	0.5 A to 200 A	1 % RDG ± 0.3 % FS	5 kHz	2 cm (.78 in) dia.
3140R	Clamp-On	2 A to 400 A	2 % RDG ± 0.04 A	20 kHz	3.2 cm (1.25 in) dia.
3100R	Clamp-On	1 A to 1000 A	1 % RDG ± 0.05 % FS	5 kHz	5 cm (2 in) dia.
3300	Clamp-On	10 A to 3000 A	2 % RDG ± 0.05 % FS	5 kHz	9 x 11 cm (3.5 x 4.5 in)



Model No.	CT Type	Current Range	Accuracy	Frequency Response	Probe Length
3110/RPM	Flexi-CT	2 A to 100 A	1 % RDG ± 0.5 % FS	7 kHz	60 cm (24 in)
3112/RPM	Flexi-CT	2 A to 100 A	1 % RDG ± 0.5 % FS	7 kHz	120 cm (48 in)
3210/RPM	Flexi-CT	20 A to 1000 A	1 % RDG ± 0.15 % FS	7 kHz	60 cm (24 in)
3212/RPM	Flexi-CT	20 A to 1000 A	1 % RDG ± 0.15 % FS	7 kHz	120 cm (48 in)
3310/RPM	Flexi-CT	100 A to 5000 A	1 % RDG ± 0.15 % FS	7 kHz	60 cm (24 in)
3312/RPM	Flexi-CT	100 A to 5000 A	1 % RDG ± 0.15 % FS	7 kHz	120 cm (48 in)



Model No.	CT Type	Current Range	Accuracy	Frequency Response	Jaw Opening
3583R	Split-Core CT	0.01 A to 10 A	1 % RDG ± 0.5 % FS	5 kHz	1 cm (.437 in)
3584R	Split-Core CT	0.1 A to 40 A	1 % RDG ± 0.5 % FS	5 kHz	1 cm (.437 in)
3585R	Split-Core CT	0.5 A to 100 A	1 % RDG ± 0.5 % FS	5 kHz	1 cm (.437 in)



宇宏企業股份有限公司 RADIOTEK CORPORATION

台北縣三重市重新路五段609巷16號6樓之1

TEL: 02-22782269 FAX: 02-22782059

Home page : www.radiotek.com.tw

E-mail : salesmag1@rdlmail.com.tw

Voltage probes

3602/RPM Battery Clip Probe

- Set of 5 battery clip type probes
- Grips conductors up to 0.9 cm (.375 in) wide
- Insulated, nickel-plated probe

3605/RPM Stud Type Probe

- 5 syringe-action voltage probes
- Threaded contact for studs/screws up to 0.9 cm (.375 in) wide

3606/RPM Screw on Probe

- 5 screw on type voltage probes
- Interchangeable threaded contacts for 3/8 in and 1/2 in studs and screws

3607/RPM Bus Bar Probe

- 5 syringe-action F-type probes
- Adjustable jaw for conductors up to 0.9 cm (.375 in) wide

3608/RPM Plunger Type Probe

- 5 syringe-action voltage probes
- Crocodile jaw for conductors up to 0.9 cm (.375 in) wide
- Plunger style, safety grip operation with insulated jaws

Cases

1750/CASE Transit Case

- Rugged water tight transit case with rollers

Miscellaneous

1750/MC

- Additional SD Memory Card for Fluke 1750

1750/SEAT-L

- Fluke Power Analyze - Additional SEAT LICENSE
- One additional license for installation on one additional PC

1750/SITE-L

- Fluke Power Analyze - Additional SITE LICENSE
- Site license for installation on unlimited PCs

4006 Security Cable

- 1.8 m (6 ft) looped lockable steel cable for securing monitor



3602



3605



3606



3607



3608



Specifications for the System: Recorder and Power Analyze Software

General

Power quality measurement standards	
Conformance	IEC 61999-1-4 Class 1, IEC 61000-4-30 Class A or B depending on measurement function, IEEE519, IEEE1159, IEEE1459
Clock/calendar	Leap years, 24-hour clock
Real-time clock accuracy	Not more than ± 1 s/day
Internal memory capacity for data	At least 1 GB
Maximum recording period	At least 31 days
Measurement time control	Automatic
Maximum number of events	Limited only by the size of the internal memory
Power requirements	100 to 240 V rms ± 10 %, 47-63 Hz, 40 W
Operating time during interruptions (internal UPS operation)	5 minutes per interruption, 60 minutes total operating time without recharging
Dimensions	215 mm x 310 mm x 35 mm (8.5 in x 12.2 in x 3.5 in)
Mass (weight)	6.3 kg (14 lb)

Input

Measurement types	One Phase Plus Neutral, One Phase IT No Neutral, One Phase Split Phase, Three Phase Wye, Three Phase Delta, Three Phase IT, Three Phase High Leg, Three Phase Open Leg, 2 Element Delta, 2 $\frac{1}{2}$ Element Wye
Input channels	Voltage: 4 channels, ac/dc Current: 5 channels
Voltage channels	Input resistance: 2 M Ω Input capacitance: < 20 pF
Current input characteristics	2 V rms = full scale, 1 M Ω Input Impedance for ferro CTs, low impedance for Flexi-CTs
Measuring method	Simultaneous digital sampling of voltage and current. Digital PLL synchronized sampling, internal frequency reference used during voltage drops.

Synchronization and sampling

PLL-synchronization source	The PLL synchronizes to the A-N voltage for wye power types, and to the A-B voltage for delta power types. All listed power types can be characterized as either wye or delta.
PLL lock range	42.5 to 69 Hz
Sampling frequency	Voltage and current: 256 samples/cycle Inter-harmonics per IEC 61000-4-7: 2560 points/10 cycles (50 Hz), 3072 points/12 cycles (60 Hz) Transient Voltage: 5 MHz
A/D resolution	Voltage and current: 24 bits Transient voltage: 14 bits

Voltage and current measurements

Voltage measurement range	AC voltage: 1000 V rms ± 10 % over range DC voltage: ± 1000 V + 10 % over range
Voltage crest factor	3 or less
Current measurement range	Depends on current probe used
Current crest factor	4 or less



宇宏企業股份有限公司 RADIOTEK CORPORATION

台北縣三重市重新路五段609巷16號6樓之1

TEL: 02-22782269 FAX: 02-22782059

Home page : www.radiotek.com.tw

E-mail : salesmag1@rdlmail.com.tw

Voltage and current measurement accuracy

RMS voltage	
Measurement type	True rms calculated continuously: every cycle, every 1/2 cycle, and every 10 or 12 cycles at 50 or 60 Hz respectively, as required by IEC 61000-4-30.
Measurement uncertainty	AC: $\pm 0.2\%$ reading $\pm 0.1\%$ full scale, above 50 V rms DC: $\pm 0.5\%$ reading $\pm 0.2\%$ full scale, above 50 V dc
RMS current	
Measurement type	True rms calculated continuously: every cycle, every 1/2 cycle, and every 10 or 12 cycles at 50 or 60 Hz respectively, as required by standards
Measurement uncertainty	<i>Ferromagnetic Clamps</i> : $\pm (0.1\%$ full scale + 0.2% reading + current sensor accuracy), valid for 5 % to 100 % of current sensor range <i>Flexible Current Probes</i> : $\pm (0.1\%$ full scale + 0.5% reading + current sensor accuracy), valid for 5 % to 100 % of current sensor range

Transient voltage (impulse)

Measurement type	Waveshape sampling
Full scale	8000 V pk
Sample resolution	200 nS
Measurement uncertainty	$\pm 5\%$ reading ± 20 V (test parameters: 1000 V dc, 1000 V rms, 100 kHz)

Dip (Sag) and Swell Measurements

Voltage swell (rms swell)	
Measurement type	True rms (one cycle calculation by overlapping each half cycle - voltage between lines is measured for 3P3W lines and phase voltage is measured for 3P4W lines)
Displayed data	Amplitude and duration of swell
Measurement uncertainty	Same as rms voltage
Voltage dip (rms sag)	
Measurement type	True rms (one cycle calculation by overlapping each half cycle - voltage between lines is measured for 3P3W lines and phase voltage is measured for 3P4W lines)
Displayed data	Amplitude and duration of dip or interruption
Measurement uncertainty	Same as rms voltage
Voltage dropout (interruption)	
Measurement type	Same as voltage dip

Power Measurements

Calculated per IEEE1459 for best performance when distortions exist	
Measurement type	True rms calculated continuously: every cycle, and every 10 or 12 cycles at 50 or 60 Hz respectively, as required by standards
Measurement accuracy	+/- (voltage uncertainty + current uncertainty + current probe uncertainty)
Frequency	
Measurement range	42.5 to 69 Hz
Measurement source	Same as PLL synchronization source
Measurement accuracy	± 10 mHz (10 to 110 % of range, with sine wave)
Power factor	
Measurement range	0.000 to 1.000
Measurement accuracy	± 1 digit from the calculation of each measured value (± 3 digits for total)
Displacement power factor	
Measurement method	Calculated from the phase difference between voltage fundamental and current fundamental
Measurement range	- 1.000 (leading) to + 1.000 (lagging)
Measurement accuracy	$\pm 0.5\%$ reading $\pm 2\%$ full scale ± 1 digit
Voltage unbalance and phase sequence	
Measurement method	Positive sequence voltage divided by negative sequence voltage, per IEC 61000-4-30
Harmonic voltage and current	
Analysis window	rectangular



宇宏企業股份有限公司 RADIOTEK CORPORATION

台北縣三重市重新路五段609巷16號6樓之1

TEL: 02-22782269 FAX: 02-22782059

Home page : www.radiotek.com.tw

E-mail : salesmag1@rdtmail.com.tw

Analysis order	1st to 50th order
Measurement accuracy	Voltage / Current: 1st to 20th orders: $\pm 0.5\%$ reading $\pm 0.2\%$ full scale, 21st to 50th orders: $\pm 1\%$ reading $\pm 0.3\%$ full scale (current sensor accuracy must be included for current and power)
Measurement method	IEC 61000-4-7
Inter-harmonic voltage and current (intermediate harmonics)	
Analysis window	rectangular
Analysis orders	1.5 to 49.5th order
Measurement method	IEC 61000-4-7

External Interface Specifications

LAN interface	
Connector	RJ-45
Speed and type	10/100 Base-T, auto MDIX
Communications protocol	TCP/IP over Ethernet
Wireless controller interface	
Connection	wireless (2.4 GHz radio)
Speed	up to 700 kbit/second
Communications protocol	Bluetooth SPP

Environmental and safety specifications

Operating environment	Indoors or in covered area outdoors, up to 2000 m altitude
Storage temperature and humidity	-20 °C to 50 °C, 80 % RH max, non-condensing
Operating temperature and humidity	0 °C to 40 °C, 80 % RH max, non-condensing
Maximum rated working voltage	
Voltage terminals	1100 V rms
Voltage durability	5550 V rms ac for 1 minute, between voltage input terminals, voltage input terminals and current probes, and voltage input terminals and case (50/60 Hz, 1 mA sense current)
Enclosure protection	IP30 (per EN 60529)
Standards conformance	
EMC	EN 61326-1:1997+A1:1998 Class A EN 61000-3-2:1995+A1:1998+A2:1998 EN 61000-3-3:1995
Safety	EN 61010-1 2nd Edition; 2000 Voltage input unit: Contamination Level 2, Overvoltage Category 1000 V CAT III, 600 V CAT IV (anticipated overvoltage: 8000 V)



宇宏企業股份有限公司 RADIOTEK CORPORATION

台北縣三重市重新路五段609巷16號6樓之1

TEL: 02-22782269 FAX: 02-22782059

Home page : www.radiotek.com.tw

E-mail : salesmag1@rdtmail.com.tw

Ordering information

Fluke-1750 Three-Phase Power Recorder

Includes:

- 1750 acquisition unit
- PDA wireless "front panel interface" and charger power plug adapters
- 4 - 400 A current probes (3140)
- 5 test leads and clips
- SD memory card
- Fluke Power View and Fluke Power Analyze software
- Power cord with international plug set
- Ethernet cable
- Color localization set
- Printed Getting Started manual
- Product CD with software and users manual PDF
- Soft carrying case (not shown)



Fluke offers a full suite of power quality test tools to locate, predict, prevent and troubleshoot power problems.

- Handheld troubleshooters for instant analysis
- Ready-to-use power loggers
- Comprehensive power quality recorders
- Power calibrators and standards backed by Fluke metrology expertise

The Fluke power quality set of products offers the highest level of performance and maintains the Fluke promise of rugged and reliable test tools.



宇宏企業股份有限公司 RADIOTEK CORPORATION

台北縣三重市重新路五段609巷16號6樓之1

TEL: 02-22782269 FAX: 02-22782059

Home page : www.radiotek.com.tw

E-mail : salesmag1@rdtmail.com.tw