

## Series 2600B

- Tightly-integrated, 4-quadrant voltage/current source and measure instruments offer best in class performance with 6 1/2 digit resolution
- Family of models offer industry's widest dynamic range: 10A pulse to 0.1fA and 200V to 100nV
- Built-in, Java-based test software enables true plug & play I/V characterization and test through any browser.
- TSP (Test Script Processing) technology embeds complete test programs inside the instrument for best-in-class system-level throughput
- TSP-Link expansion technology for multi-channel parallel test without a mainframe
- Software emulation for Keithley's Model 2400 SourceMeter SMU Instrument
- USB 2.0, LXI-C, GPIB, RS-232, and digital I/O interfaces
- Free software drivers and development/debug tools
- Optional ACS-Basic semiconductor component characterization software

## System SourceMeter® SMU (Source-Measure Unit) Instruments



The Series 2600B System SourceMeter SMU Instruments are the industry's leading current/voltage source and measure solutions, and are built from Keithley's 3rd generation SMU technology. The Series 2600B offers single- and dual-channel models that combine the capabilities of a Precision Power Supply, true Current Source, 1/2 digit DMM, Arbitrary Waveform Generator, Pulse Generator, and Electronic Load – all into one tightly integrated instrument. The result is a powerful solution that significantly boosts productivity in applications ranging from bench-top I/V characterization through highly-automated production test. For bench-top use, Series 2600B instruments feature built-in, Java-based software that enables plug & play I/V testing through any browser, on any computer, from anywhere in the world. For automated system applications, the Series 2600B's Test Script Processor (TSP) runs complete test programs from inside the instrument for industry-best throughput. In larger, multi-channel applications, Keithley's TSP-Link technology works together with TSP to enable high-speed, SMU-per-pin parallel testing. Because Series 2600B SourceMeter SMU Instruments have fully isolated channels that do not require a mainframe, they can be easily re-configured and re-deployed as your test applications evolve.

### Java-based Plug & Play I/V Test Software

The Series 2600B are the only SMU instruments to feature built-in, Java-based test software that enables true plug & play I/V characterization through any browser, on any computer, from anywhere in the world. This unique capability boosts productivity across a wide range of applications such as R&D, education, QA/FA, and more. Simply connect the 2600B to the internet via the supplied LAN cable, open a browser, type in the 2600B's I.P. address, and begin testing. Resulting data can be downloaded to a spreadsheet such as Excel for further analysis and formatting, or for inclusion in other documents or presentations.



Built-in, Java-based test software runs directly from any web browser to boost productivity.

1.888.KEITHLEY (U.S. only)  
[www.keithley.com](http://www.keithley.com)

KEITHLEY

A GREATER MEASURE OF CONFIDENCE

# Series 2600B

## Ordering Information

2601B	Single-channel System SourceMeter Instrument (3A DC, 10A Pulse)
2602B	Dual-channel System SourceMeter Instrument (3A DC, 10A Pulse)
2604B	Dual-channel System SourceMeter Instrument (3A DC, 10A Pulse, Benchtop Version)
2611B	Single-channel System SourceMeter Instrument (200V, 10A Pulse)
2612B	Dual-channel System SourceMeter Instrument (200V, 10A Pulse)
2614B	Dual-channel System SourceMeter Instrument (200V, 10A Pulse, Benchtop Version)
2634B	Dual-channel System SourceMeter Instrument (0.1fA, 10A Pulse, Benchtop Version)
2635B	Single-channel System SourceMeter Instrument (0.1fA, 10A Pulse)
2636B	Dual-channel System SourceMeter Instrument (0.1fA, 10A Pulse)

## Accessories Supplied

### Operators and Programming Manuals

2600-ALG-2: Low Noise Triax Cable with Alligator Clips, 2m (6.6 ft.) (two supplied with 2604B and 2636B, one with 2635B)

2600-Kit: Mating Terminals, Terminal Connectors with strain relief and covers (2601B/2602B/2604B/2611B/2612B/2614B)

CA-180-3A: TSP-Link/Ethernet Cable (two per unit)

TSP Express Software Tool (embedded)

Test Script Builder Software (supplied on CD)

LabVIEW Driver

ACS Basic Edition Software (optional)

# System SourceMeter® SMU (Source-Measure Unit) Instruments

## Unmatched Throughput for Automated Test with TSP Technology

For test applications that demand the highest levels of automation and throughput, the Model 2600B's TSP technology delivers industry-best performance. TSP technology goes far beyond traditional test command sequencers... it fully embeds then executes complete test programs from within the SMU instrument itself. This virtually eliminates all the time-consuming bus communications to and from the PC controller, and thus dramatically improves overall test times.

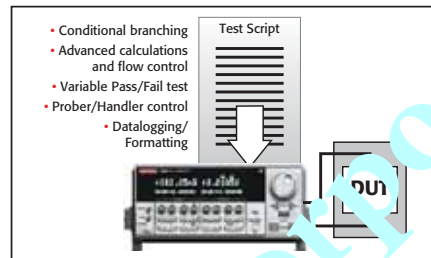

TSP technology executes complete test programs from the 2600B's non-volatile memory.

## SMU-Per-Pin Parallel Testing with TSP-Link Technology

TSP-Link is a channel expansion bus that enables multiple Series 2600B's to be inter-connected and function as a single, tightly-synchronized, multi-channel system. The 2600B's TSP-Link technology works together with its TSP technology to enable high-speed, SMU-per-pin parallel testing. Unlike other high-speed solutions such as large ATE systems, the 2600B achieves parallel test performance without the cost or burden of a mainframe. The TSP-Link based system also enables superior flexibility, allowing for quick and easy system re-configuration as test requirements change.

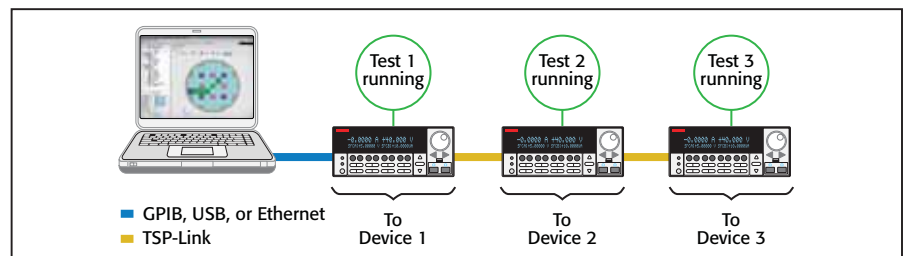

SMU-Per-Pin Parallel Testing using TSP and TSP-Link improves test throughput and lowers the cost of test.

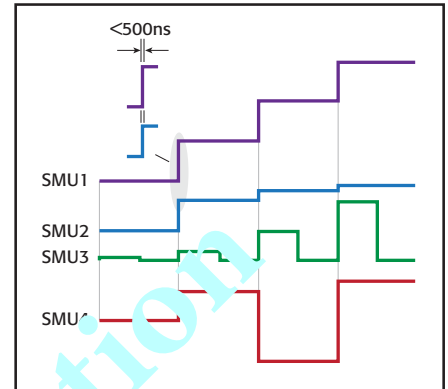

All channels in the TSP-Link system are synchronized to under 500ns.

## Model 2400 Software Emulation

The Series 2600B is compatible with test code developed for Keithley's Model 2400 SourceMeter SMU instrument. This enables an easier upgrade from Model 2400-based test systems to Series 2600B, and can improve test speeds by as much as 80%. In addition, it provides a migration path from SCPI programming to Keithley's TSP technology, which when implemented can improve test times even more. For complete support of legacy test systems, the Model 2400's Source-Memory-List test sequencer is also fully supported in this mode.

## Third-generation SMU Instrument Design Ensures Faster Test Times

Based on the proven architecture of earlier Series 2600 instruments, the Series 2600B's SMU instrument design enhances test speed in several ways. For example, while earlier designs used a parallel current ranging topology, the Series 2600B uses a patented series ranging topology, which provides faster and smoother range changes and outputs that settle more quickly.

1.888.KEITHLEY (U.S. only)

[www.keithley.com](http://www.keithley.com)

KEITHLEY

A GREATER MEASURE OF CONFIDENCE

# Series 2600B

# System SourceMeter® SMU (Source-Measure Unit) Instruments

The Series 2600B SMU instrument design supports two modes of operation for use with a variety of loads. In normal mode, the SMU instrument provides high bandwidth performance for maximum throughput. In high capacitance (high-C) mode, the SMU instrument uses a slower bandwidth to provide robust performance with higher capacitive loads.

## Simplify Semiconductor Component Test, Verification, and Analysis

The optional ACS Basic Edition software maximizes the productivity of customers who perform packaged part characterization during development, quality verification, or failure analysis. Key features include:

- Rich set of easy-to-access test libraries
- Script editor for fast customization of existing tests
- Data tool for comparing results quickly
- Formulator tool that analyzes captured curves and provides a wide range of math functions

For more information about the ACS Basic Edition software, please refer to the ACS Basic Edition data sheet.

## Powerful Software Tools

In addition to the embedded Java-based plug & play software and optional ACS Basic Edition software, the free Test Script Builder software tool is provided to help users create, modify, debug, and store TSP test scripts. Table 1 describes key features of Series 2600B software tools.

## Three new dual-channel bench-top models of Series 2600B offer the industry-best value and performance.

For applications that do not require leading-edge system-level automation capabilities, Keithley has expanded the 2600 series to include 3 new value-priced “bench-top” models – the 2604B, 2614B, and 2634B. These models offer similar performance to Models 2602B, 2612B, and 2636B, respectively, however do not include TSP-Link, Contact Check, and Digital I/O capabilities.

## Complete Automated System Solutions

Keithley’s S500 Integrated Test Systems are highly configurable, instrument-based systems for semiconductor characterization at the device, wafer, or cassette level. Built on our proven Series 2600 System SourceMeter SMU instruments, our S500 Integrated Test Systems

Table 1. Series 2600B software tools

Feature/Functionality	ACS Basic Edition	Java-based Plug & Play	Test Script Builder (TSB)
Description	Semiconductor characterization software for component test, verification, and analysis	Quick Start Java-based Plug & Play Tool for fast and easy I-V testing, primarily for bench and lab users	Custom script writing tool for TSP instruments
Supported hardware	Series 2400, Series 2600B, 4200-SCS	Series 2600B	Series 2600B, Series 3700
Supported buses	GPIB, LAN/LXI	LAN/LXI	GPIB, RS-232, LAN/LXI, USB
Functionality	Intuitive, wizard-based GUI, Rich set of test libraries, curve trace capability	Linear/Log Sweeps, Pulsed Custom sweeps, Single point source-measures. Note: New 2600B series offers precision time and channel synchronization	Custom scripts with total flexibility, full featured debugger
Data management	Formulator tool with wide range of math functions	Export	User defined
Installation	Optional purchase	Not necessary. Included in the instrument.	Free Download or CD Install on PC.

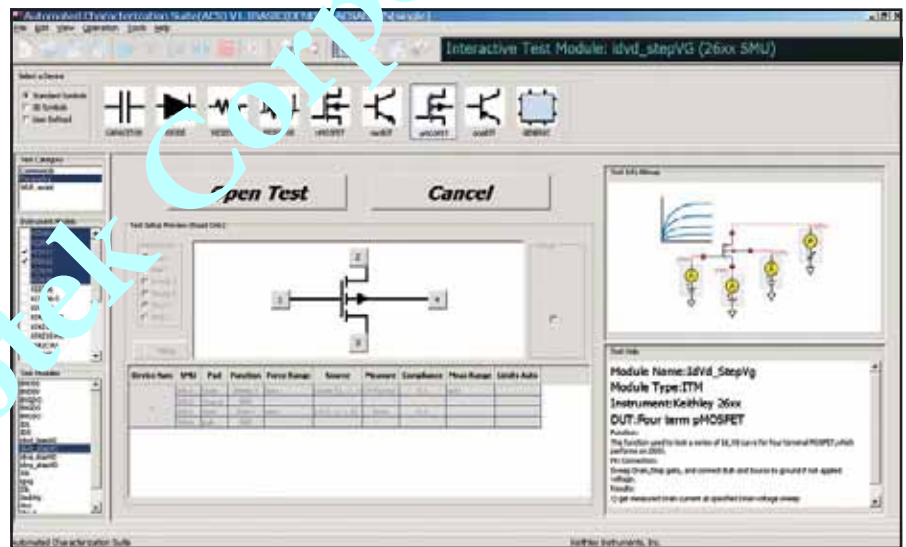

**When you need to acquire data on a packaged part quickly, the wizard-based user interface of ACS Basic Edition makes it easy to find and run the test you want, like this common FET curve trace test.**

provide innovative measurement features and system flexibility, scalable to your needs. The unique measurement capability, combined with the powerful and flexible Automated Characterization Suite (ACS) software, provides a comprehensive range of applications and features not offered on other comparable systems on the market.



**The flexible software architecture of ACS Basic Edition allows configuring systems with a wide range of controllers and test fixtures, as well as the exact number of SourceMeter instruments the application requires.**

**1.888.KEITHLEY (U.S. only)**  
**www.keithley.com**

**KEITHLEY**

A GREATER MEASURE OF CONFIDENCE

Scalable, integrated source and measure solutions

SMU INSTRUMENTS

# Series 2600B

## System SourceMeter® SMU (Source-Measure Unit) Instruments

### TYPICAL APPLICATIONS

I-V functional test and characterization of a wide range of devices, including:

- Discrete and passive components
  - Two-leaded – Sensors, disk drive heads, metal oxide varistors (MOVs), diodes, zener diodes, sensors, capacitors, thermistors
  - Three-leaded – Small signal bipolar junction transistors (BJTs), field-effect transistors (FETs), and more
- Simple ICs – Optos, drivers, switches, sensors, converters, regulators
- Integrated devices – small scale integrated (SSI) and large scale integrated (LSI)
  - Analog ICs
  - Radio frequency integrated circuits (RFICs)
  - Application specific integrated circuits (ASICs)
  - System on a chip (SOC) devices
- Optoelectronic devices such as light-emitting diodes (LEDs), laser diodes, high brightness LEDs (HBLEDs), vertical cavity surface-emitting lasers (VCSELs), displays
- Wafer level reliability
  - NBTI, TDDDB, HCI, electromigration
- Solar Cells
- Batteries
- And more...

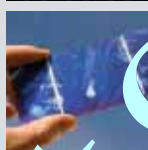
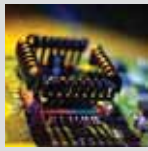

In the first and third quadrants, Series 2600B instruments operate as a source, delivering power to a load. In the second and fourth quadrants, they operate as a sink, dissipating power internally.

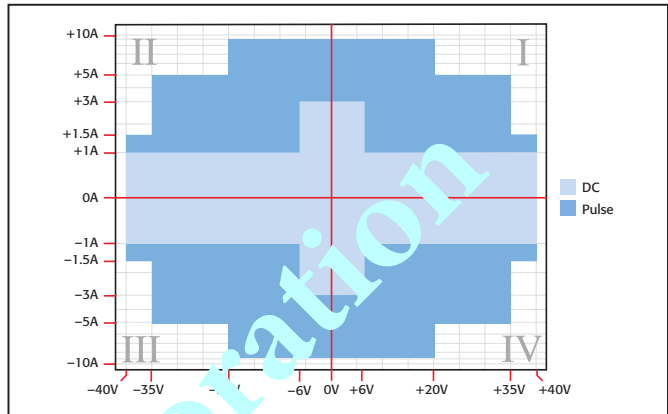

Models 2601B, 2602B, and 2604B I-V capability

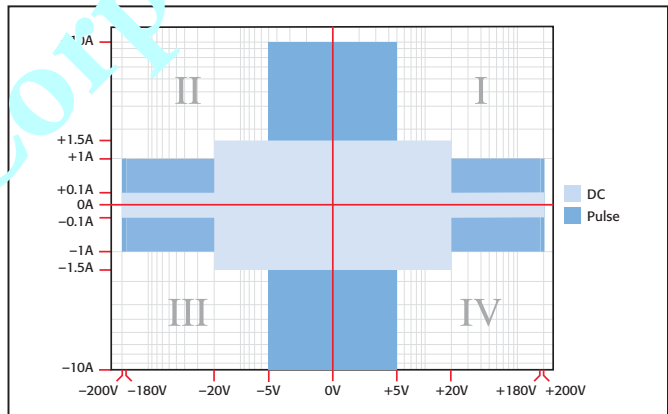

Models 2611B, 2612B, and 2614B I-V capability

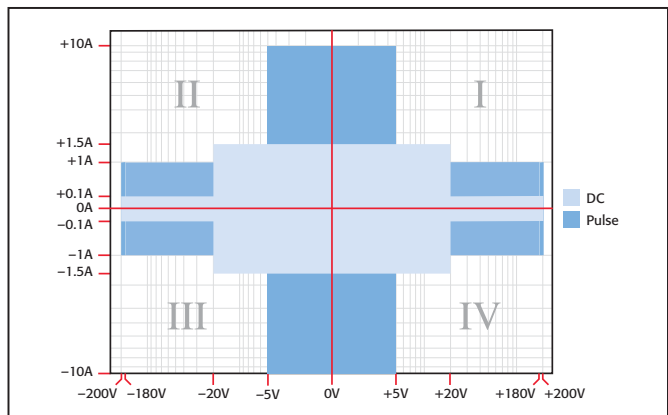

Models 2634B, 2635B, and 2636B I-V capability



Model 2604B/2614B rear panel  
(Single channels 2601B, 2611B, 2635B not shown)



Model 2636B rear panel

1.888.KEITHLEY (U.S. only)

[www.keithley.com](http://www.keithley.com)



A GREATER MEASURE OF CONFIDENCE

# 2601B, 2602B, 2604B

# System SourceMeter® SMU (Source-Measure Unit) Instruments

## SPECIFICATION CONDITIONS

This document contains specifications and supplemental information for the Models 2601B, 2602B, and 2604B System SourceMeter® instruments. Specifications are the standards against which the Models 2601B, 2602B, and 2604B are tested. Upon leaving the factory, the 2601B, 2602B, and 2604B meet these specifications. Supplemental and typical values are non-warranted, apply at 23°C, and are provided solely as useful information.

Accuracy specifications are applicable for both normal and high capacitance modes.

The source and measurement accuracies are specified at the SourceMeter CHANNEL A (2601B, 2602B, and 2604B) or SourceMeter CHANNEL B (2602B and 2604B) terminals under the following conditions:

1. 23°C ± 5°C, <70% relative humidity
2. After 2 hour warm-up
3. Speed normal (1 NPLC)
4. A/D auto-zero enabled
5. Remote sense operation or properly zeroed local operation
6. Calibration period = 1 year

## SOURCE SPECIFICATIONS

### VOLTAGE SOURCE SPECIFICATIONS

#### VOLTAGE PROGRAMMING ACCURACY<sup>1</sup>

Range	Programming Resolution	Accuracy (1 Year) 23°C ±5°C ±(% rdg. + volts)	Typical Noise (peak-peak) 0.1Hz–10Hz
100 mV	5 µV	0.02% + 250 µV	20 µV
1 V	50 µV	0.02% + 400 µV	50 µV
6 V	50 µV	0.02% + 1.8 mV	100 µV
40 V	500 µV	0.02% + 12 mV	500 µV

TEMPERATURE COEFFICIENT (0°–18°C and 28°–50°C): ±(0.15 × accuracy specification)/°C.

Applicable for normal mode only. Not applicable for high capacitance mode.

MAXIMUM OUTPUT POWER AND SOURCE/SINK LIMITS<sup>2</sup>: 40.4W per channel maximum.  
±40.4V @ ±1.0A, ±6.06V @ ±3.0A, four quadrant source or sink operation.

VOLTAGE REGULATION: Line: 0.01% of range. Load: ±(0.01% of range + 100 µV)

NOISE 10Hz–20MHz: <20mV peak-peak (typical), <3mV RMS (typical), 6V range

CURRENT LIMIT/COMPLIANCE<sup>3</sup>: Bipolar current limit (compliance) set with a single value.  
Minimum value is 10nA. Accuracy same as current source.

OVERSHOOT: <±(0.1% + 10mV) typical. Step size = 10% to 90% of range, resistive load,  
maximum current limit/compliance.

GUARD OFFSET VOLTAGE: <4mV typical. Current <10mA.

### CURRENT SOURCE SPECIFICATIONS

#### CURRENT PROGRAMMING ACCURACY

Range	Programming Resolution	Accuracy (1 Year) 23°C ±5°C ±(% rdg. + amps)	Typical Noise (peak-peak) 0.1Hz–10Hz
100 nA	2 pA	±0.06% + 100 pA	5 pA
1 µA	100 pA	0.03% + 800 pA	25 pA
10 µA	200 pA	0.03% + 5 nA	60 pA
100 µA	2 nA	0.03% + 60 nA	3 nA
1 mA	20 nA	0.03% + 300 nA	6 nA
10 mA	200 nA	0.03% + 6 µA	200 nA
100 mA	2 µA	0.03% + 30 µA	600 nA
1 A <sup>5</sup>	20 µA	0.05% + 1.8 mA	70 µA
3 A <sup>5</sup>	20 µA	0.06% + 4 mA	150 µA
10 A <sup>5,6</sup>	200 µA	0.5% + 40 mA (typical)	

TEMPERATURE COEFFICIENT (0°–18°C and 28°–50°C): ±(0.15 × accuracy specification)/°C.

MAXIMUM OUTPUT POWER AND SOURCE/SINK LIMITS<sup>2</sup>: 40.4W per channel maximum.  
±1.01A @ ±40.0V, ±3.03A @ ±6.0V, four quadrant source or sink operation.

CURRENT REGULATION: Line: 0.01% of range. Load: ±(0.01% of range + 100pA).

VOLTAGE LIMIT/COMPLIANCE<sup>3</sup>: Bipolar voltage limit (compliance) set with a single value.  
Minimum value is 10mV. Accuracy is the same as voltage source.

OVERSHOOT: <±0.1% typical (step size = 10% to 90% of range, resistive load; see Current Source  
Output Settling Time for additional test conditions).

### ADDITIONAL SOURCE SPECIFICATIONS

TRANSIENT RESPONSE TIME: <70µs for the output to recover to within 0.1% for a 10% to 90%  
step change in load.

VOLTAGE SOURCE OUTPUT SETTLING TIME: Time required to reach within 0.1% of final value  
after source level command is processed on a fixed range.

100mV, 1V Ranges: <50µs typical.

6V Range: <100µs typical.

40V Range<sup>10</sup>: <150µs typical.

CURRENT SOURCE OUTPUT SETTLING TIME: Time required to reach within 0.1% of final value  
after source level command is processed on a fixed range. Values below for I<sub>out</sub> × R<sub>load</sub> = 1V  
unless noted.

3A Range: <80µs typical (current less than 2.5A, R<sub>load</sub> >25Ω).

1A–10mA Ranges: <80µs typical (R<sub>load</sub> >6Ω).

1mA Range: <100µs typical.

100µA Range: <150µs typical.

10µA Range: <500µs typical.

1µA Range: <2.5ms typical.

100nA Range: <25ms typical.

DC FLOATING VOLTAGE: Output can be floated up to ±250VDC from chassis ground.

REMOTE SENSE OPERATING RANGE<sup>11</sup>:

Maximum voltage between HI and SENSE HI = 3V.

Maximum voltage between LO and SENSE LO = 3V.

VOLTAGE OUTPUT HEADROOM:

40V Range: Max. output voltage = 42V – total voltage drop across source leads (maximum 1Ω  
per source lead).

6V Range: Max. output voltage = 8V – total voltage drop across source leads (maximum 1Ω per  
source lead).

OVERTEMPERATURE PROTECTION: Internally sensed temperature overload puts unit in  
standby mode.

VOLTAGE SOURCE RANGE CHANGE OVERSHOOT: <300mV + 0.1% of larger range (typical).  
Overshoot into an 100kΩ load, 20MHz BW.

CURRENT SOURCE RANGE CHANGE OVERSHOOT: <5% of larger range + 300mV/R<sub>load</sub> (typical  
with source settling set to SETTLE\_SMOOTH\_100NA). See Current Source Output Settling Time  
for additional test conditions.

### NOTES

1. Add 50µV to source accuracy specifications per volt of HI lead drop.
2. High Capacitance Mode accuracy is applicable at 23°C ±5°C only.
3. Full power source operation regardless of load to 30°C ambient. Above 30°C and/or power sink operation, refer to "Operating Boundaries" in the Series 2600B Reference Manual for additional power derating information.
4. For sink mode operation (quadrants II and IV), add 0.06% of limit range to the corresponding current limit accuracy specifications. Specifications apply with sink mode operation enabled.
5. Full power source operation regardless of load to 30°C ambient. Above 30°C and/or power sink operation, refer to "Operating Boundaries" in the Series 2600B Reference Manual for additional power derating information.
6. 10A range accessible only in pulse mode.
7. High Capacitance Mode accuracy is applicable at 23°C ±5°C only.
8. Full power source operation regardless of load to 30°C ambient. Above 30°C and/or power sink operation, refer to "Operating Boundaries" in the Series 2600B Reference Manual for additional power derating information.
9. For sink mode operation (quadrants II and IV), add 10% of compliance range and ±0.02% of limit setting to corresponding voltage source specification. For 100mV range add an additional 60mV of uncertainty.
10. Add 150µs when measuring on the 1A range.
11. Add 50µV to source accuracy specifications per volt of HI lead drop.

1.888.KEITHLEY (U.S. only)

www.keithley.com

KEITHLEY

A GREATER MEASURE OF CONFIDENCE

# 2601B, 2602B, 2604B

# System SourceMeter® SMU (Source-Measure Unit) Instruments

## SOURCE SPECIFICATIONS (continued)

### PULSE SPECIFICATIONS

Region	Maximum Current Limit	Maximum Pulse Width <sup>12</sup>	Maximum Duty Cycle <sup>13</sup>
1	1 A @ 40 V	DC, no limit	100%
1	3 A @ 6 V	DC, no limit	100%
2	1.5 A @ 40 V	100 ms	25%
3	5 A @ 35 V	4 ms	4%
4	10 A @ 20 V	1.8 ms	1%

MINIMUM PROGRAMMABLE PULSE WIDTH<sup>14, 15</sup>: 100 $\mu$ s. NOTE: Minimum pulse width for settled source at a given I/V output and load can be longer than 100 $\mu$ s.

PULSE WIDTH PROGRAMMING RESOLUTION: 1 $\mu$ s.

PULSE WIDTH PROGRAMMING ACCURACY<sup>15</sup>:  $\pm 5\mu$ s.

PULSE WIDTH JITTER: 2 $\mu$ s (typical).

QUADRANT DIAGRAM:

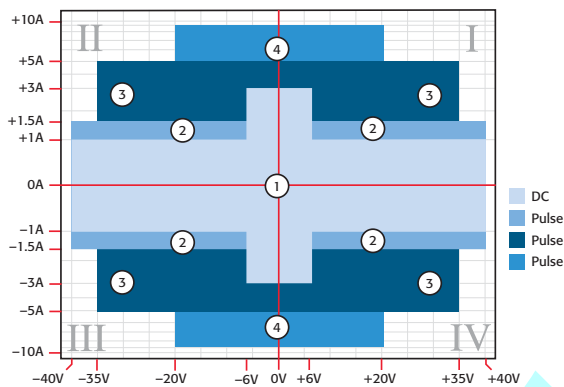

### NOTES

12. Times measured from the start of pulse to the start off-time; see figure below.

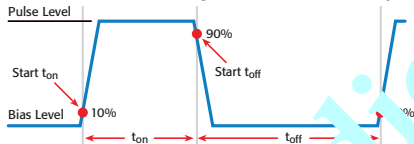

13. Thermally limited in sink mode (quadrants II and IV) at ambient temperatures above 30°C. See power equations in the reference manual for more information.

14. Typical performance for minimum settled pulse width.

Source Value	Load	Source Settling (% of range)	Min. Pulse Width
6 V	2 $\Omega$	0.2%	150 $\mu$ s
20 V	7 $\Omega$	1%	200 $\mu$ s
35 V	2 $\Omega$	0.5%	500 $\mu$ s
40 V	27 $\Omega$	0.1%	400 $\mu$ s
1.5 A	27 $\Omega$	0.1%	1.5 ms
3 A	2 $\Omega$	0.2%	150 $\mu$ s
5 A	7 $\Omega$	0.5%	500 $\mu$ s
10 A	2 $\Omega$	0.5%	200 $\mu$ s

Typical tests were performed using remote operation, 4W sense, and best, fixed measurement range. For more information on pulse scripts, see the Series 2600B Reference Manual.

15. Times measured from the start of pulse to the start off-time; see figure below.

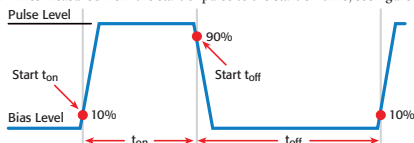

1.888.KEITHLEY (U.S. only)

www.keithley.com

## METER SPECIFICATIONS

### VOLTAGE MEASUREMENT ACCURACY<sup>16, 17</sup>

Range	Default Display Resolution <sup>18</sup>	Input Resistance	Accuracy (1 Year) 23°C $\pm 5^\circ$ C $\pm$ (% rdg. + volts)
100 mV	100 nV	>10 G $\Omega$	0.015% + 150 $\mu$ V
1 V	1 $\mu$ V	>10 G $\Omega$	0.015% + 200 $\mu$ V
6 V	10 $\mu$ V	>10 G $\Omega$	0.015% + 1 mV
40 V	10 $\mu$ V	>10 G $\Omega$	0.015% + 8 mV

TEMPERATURE COEFFICIENT (0°–18°C and 28°–50°C)<sup>19</sup>:  $\pm(0.15 \times \text{accuracy specification})/^\circ\text{C}$ . Applicable for normal mode only. Not applicable for high capacitance mode.

### CURRENT MEASUREMENT ACCURACY<sup>20</sup>

Range	Default Display Resolution <sup>20</sup>	Voltage Burden	Accuracy (1 Year) 23°C $\pm 5^\circ$ C $\pm$ (% rdg. + amps)
100 nA	100 fA	<1 mV	0.05% + 100 pA
1 $\mu$ A	1 pA	<1 mV	0.025% + 500 pA
10 $\mu$ A	10 pA	<1 mV	0.025% + 1.5 nA
100 $\mu$ A	100 pA	<1 mV	0.02% + 25 nA
1 mA	10 nA	<1 mV	0.02% + 200 nA
10 mA	100 nA	<1 mV	0.02% + 2.5 $\mu$ A
100 mA	100 nA	<1 mV	0.02% + 20 $\mu$ A
1 A	1 $\mu$ A	<1 mV	0.03% + 1.5 mA
3 A	1 $\mu$ A	<1 mV	0.05% + 3.5 mA
10 A <sup>22</sup>	10 $\mu$ A	<1 mV	0.4% + 25 mA (typical)

CURRENT MEASUREMENT SETTLING TIME (Time for measurement to settle after a  $V_{\text{step}}$ )<sup>23</sup>: Time required to reach within 0.1% of final value after source level command is processed on a fixed load. Values for  $V_{\text{out}} = 1$  V unless noted. Current Range: 1 mA. Settling Time: <100 $\mu$ s (typical).

TEMPERATURE COEFFICIENT (0°–18°C and 28°–50°C)<sup>24</sup>:  $\pm(0.15 \times \text{accuracy specification})/^\circ\text{C}$ . Applicable for normal mode only. Not applicable for high capacitance mode.

### CONTACT CHECK<sup>25</sup> (not available on Model 2604B)

Speed	Maximum Measurement Time To Memory For 60Hz (50Hz)	Accuracy (1 Year) 23°C $\pm 5^\circ$ C $\pm$ (%rdg. + ohms)
FAST	1 (1.2) ms	5% + 10 $\Omega$
MEDIUM	4 (5) ms	5% + 1 $\Omega$
SLOW	36 (42) ms	5% + 0.3 $\Omega$

### ADDITIONAL METER SPECIFICATIONS

MAXIMUM LOAD IMPEDANCE:

Normal Mode: 10nF (typical). High Capacitance Mode: 50 $\mu$ F (typical).

COMMON MODE VOLTAGE: 250VDC.

COMMON MODE ISOLATION: >1G $\Omega$ , <4500pF.

OVERRANGE: 101% of source range, 102% of measurement range.

MAXIMUM SENSE LEAD RESISTANCE: 1k $\Omega$  for rated accuracy.

SENSE INPUT IMPEDANCE: >10G $\Omega$ .

### NOTES

16. Add 50 $\mu$ V to source accuracy specifications per volt of HI lead drop.

17. De-rate accuracy specifications for NPLC setting < 1 by increasing error term.

Add appropriate % of range term using table below.

NPLC Setting	100mV Range	1V–40V Ranges	100nA Range	1 $\mu$ A–100mA Ranges	1A–3A Ranges
0.1	0.01%	0.01%	0.01%	0.01%	0.01%
0.01	0.08%	0.07%	0.1%	0.05%	0.05%
0.001	0.8%	0.6%	1%	0.5%	1.1%

18. Applies when in single channel display mode.

19. High Capacitance Mode accuracy is applicable for 23°C  $\pm 5^\circ$ C only.

20. Applies when in single channel display mode.

21. Four-wire remote sense only with current meter mode selected. Voltage measure set to 100mV or 1V range only.

22. 10A range accessible only in pulse mode.

23. Compliance equal to 100mA.

24. High Capacitance Mode accuracy is applicable for 23°C  $\pm 5^\circ$ C only.

25. Includes measurement of SENSE HI to HI and SENSE LO to LO contact resistances.

KEITHLEY

A GREATER MEASURE OF CONFIDENCE

# 2601B, 2602B, 2604B

# System SourceMeter® SMU (Source-Measure Unit) Instruments

## HIGH CAPACITANCE MODE<sup>26, 27, 28</sup>

**VOLTAGE SOURCE OUTPUT SETTLING TIME:** Time required to reach 0.1% of final value after source level command is processed on a fixed range. Current limit = 1A.

Voltage Source Range	Settling Time with $C_{load} = 4.7\mu F$
100 mV	200 $\mu s$ (typical)
1 V	200 $\mu s$ (typical)
6 V	200 $\mu s$ (typical)
40 V	7 ms (typical)

**CURRENT MEASURE SETTLING TIME:** Time required to reach 0.1% of final value after voltage source is stabilized on a fixed range. Values below for  $V_{out} = 1V$  unless noted.

Current Measure Range	Settling Time
3 A – 1 A	<120 $\mu s$ (typical) ( $R_{load} > 2\Omega$ )
100 mA – 10 mA	<100 $\mu s$ (typical)
1 mA	< 3 ms (typical)
100 $\mu A$	< 3 ms (typical)
10 $\mu A$	< 230 ms (typical)
1 $\mu A$	< 230 ms (typical)

**CAPACITOR LEAKAGE PERFORMANCE USING HIGH-C SCRIPTS<sup>29</sup>:** Load =  $5\mu F || 10M\Omega$ .

Test: 5V step and measure. 200ms (typical) @ 50nA.

**MODE CHANGE DELAY:**

**100 $\mu A$  Current Range and Above:**  
 Delay into High Capacitance Mode: 10ms.  
 Delay out of High Capacitance Mode: 10ms.  
**1 $\mu A$  and 10 $\mu A$  Current Ranges:**  
 Delay into High Capacitance Mode: 230ms.  
 Delay out of High Capacitance Mode: 10ms.

**VOLTMETER INPUT IMPEDANCE:** 10G $\Omega$  in parallel with 3300pF.

**NOISE, 10Hz–20MHz (6V Range):** <30mV peak-peak (typical).

**VOLTAGE SOURCE RANGE CHANGE OVERTHOOT:** <4%  $V_{out}$  + 5% of larger range (typical).  
 Overshoot into a 100k $\Omega$  load, 20MHz BW.

### NOTES

26. High Capacitance Mode specifications are for DC measurements only.

27. 100nA range is not available in High Capacitance Mode.

28. High Capacitance Mode utilizes locked range. Auto Range is disabled.

29. Part of KI Factory scripts. See reference manual for details.

## GENERAL

**IEEE-488:** IEEE-488.1 compliant. Supports IEEE-488.2 common commands and status model topology.

**USB CONTROL (REAR):** USB 2.0 device, TMC488 protocol.

**RS-232:** Baud rates from 300bps to 115200bps.

**ETHERNET:** RJ-45 connector, LXI Class C, 10/100BT, no auto MDIX.

**EXPANSION INTERFACE:** The TSP-Link expansion interface allows TSP enabled instruments to trigger and communicate with each other. (Not available on Model 2604B)

**Cable Type:** Category 5e or higher LAN crossover cable.

**Length:** 3 meters maximum between each TSP enabled instrument.

**LXI COMPLIANCE:** LXI Class C 1.4.

**LXI TIMING:** Total Output Trigger Response Time: 245 $\mu s$  min., 280 $\mu s$  max. (not specified) max. Receive LAN[0-7] Event Delay: Unknown. Generate LAN[0-7] Event Delay: Unknown.

**DIGITAL I/O INTERFACE:** (Not available on Model 2604B)

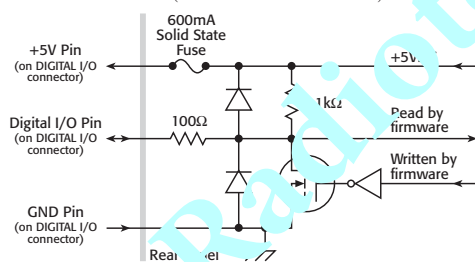

**Connector:** 25-pin female D.

**Input/Output Pins:** 14 open drain I/O bits.

**Absolute Maximum Input Voltage:** 5.25V.

**Absolute Minimum Input Voltage:** -0.25V.

**Maximum Logic Low Input Voltage:** 0.7V, +850 $\mu A$  max.

**Minimum Logic High Input Voltage:** 2.1V, +570 $\mu A$ .

**Maximum Source Current (flowing out of Digital I/O bit):** +960 $\mu A$ .

**Maximum Sink Current @ Maximum Logic Low Voltage (0.7V):** -5.0mA.

**Absolute Maximum Sink Current (flowing into Digital I/O pin):** -11mA (not including Model 2604B).

**5V Power Supply Pin:** Limited to 600mA, solid state fuse protected.

**Output Enable:** Active high input pulled down internally to ground with a 10k $\Omega$  resistor; when the output enable input function has been activated, each SourceMeter channel will not turn on unless the output enable pin is driven to >2.1V (nominal current = 2.1V/10k $\Omega$  = 210 $\mu A$ ).

**USB FILE SYSTEM (FRONT):** USB 2.0 Host: Mass storage class device.

**POWER SUPPLY:** 100V to 250VAC, 50–60Hz (auto sensing), 240VA max.

**COOLING:** Forced air. Side intake and rear exhaust. One side must be unobstructed when rack mounted.

**EMC:** Conforms to European Union Directive 2004/108/EEC, EN 61326-1.

**SAFETY:** Conforms to European Union Directive 73/23/EEC, EN 61010-1, and UL 61010-1.

**DIMENSIONS:** 89mm high  $\times$  213mm wide  $\times$  460mm deep (3 $\frac{1}{2}$  in  $\times$  8 $\frac{3}{8}$  in  $\times$  17 $\frac{1}{2}$  in). Bench Configuration (with handle and feet): 104mm high  $\times$  238mm wide  $\times$  460mm deep (4 $\frac{1}{8}$  in  $\times$  9 $\frac{3}{8}$  in  $\times$  17 $\frac{1}{2}$  in).

**WEIGHT:** 2601B: 4.75kg (10.4 lbs). 2602B, 2604B: 5.50kg (12.0 lbs).

**ENVIRONMENT:** For indoor use only.

**Altitude:** Maximum 2000 meters above sea level.

**Operating:** 0°–50°C, 70% R.H. up to 35°C. Derate 3% R.H./°C, 35°–50°C.

**Storage:** -25°C to 65°C.

SEE PAGES 14 AND 15 FOR MEASUREMENT SPEEDS AND OTHER SPECIFICATIONS.

1.888.KEITHLEY (U.S. only)

www.keithley.com

KEITHLEY

A GREATER MEASURE OF CONFIDENCE

# 2611B, 2612B, 2614B

# System SourceMeter® SMU (Source-Measure Unit) Instruments

## SPECIFICATION CONDITIONS

This document contains specifications and supplemental information for the Models 2611B, 2612B, and 2614B System SourceMeter® instruments. Specifications are the standards against which the Models 2611B, 2612B, and 2614B are tested. Upon leaving the factory the 2611B, 2612B, and 2614B meet these specifications. Supplemental and typical values are non-warranted, apply at 23°C, and are provided solely as useful information.

Accuracy specifications are applicable for both normal and high capacitance modes.

The source and measurement accuracies are specified at the SourceMeter CHANNEL A (2611B, 2612B, and 2614B) or SourceMeter CHANNEL B (2612B, 2614B) terminals under the following conditions:

- 23°C ± 5°C, <70% relative humidity.
- After 2 hour warm-up.
- Speed normal (1 NPLC).
- A/D auto-zero enabled.
- Remote sense operation or properly zeroed local sense operation.
- Calibration period = 1 year.

## SOURCE SPECIFICATIONS

### VOLTAGE SOURCE SPECIFICATIONS

#### VOLTAGE PROGRAMMING ACCURACY<sup>1</sup>

Range	Programming Resolution	Accuracy (1 Year) 23°C ± 5°C ±(% rdg. + volts)	Typical Noise (Peak-Peak) 0.1Hz–10Hz
200 mV	5 μV	0.02% + 375 μV	20 μV
2 V	50 μV	0.02% + 600 μV	50 μV
20 V	500 μV	0.02% + 5 mV	300 μV
200 V	5 mV	0.02% + 50 mV	2 mV

TEMPERATURE COEFFICIENT (0°–18°C and 28°–50°C)<sup>2</sup>: ±(0.15 × accuracy specification) %/°C. Applicable for normal mode only. Not applicable for high capacitance mode.

MAXIMUM OUTPUT POWER AND SOURCE/SINK LIMITS<sup>3</sup>: 30.3W per channel maximum. ±20.2V @ ±1.5A, ±202V @ ±100mA, four quadrant source or sink operation.

VOLTAGE REGULATION: Line: 0.01% of range. Load: ±(0.01% of range + 100 μV).

NOISE 10Hz–20MHz: <20mV peak-peak (typical), <3mV RMS (typical), 20V range.

CURRENT LIMIT/COMPLIANCE<sup>4</sup>: Bipolar current limit (compliance) set with a single value. Minimum value is 10nA. Accuracy is the same as current source.

OVERSHOOT: <±(0.1% + 10mV) (typical). Step size = 10% to 90% of range, resistive load, maximum current limit/compliance.

GUARD OFFSET VOLTAGE: <4mV (current <10mA).

### CURRENT SOURCE SPECIFICATIONS

#### CURRENT PROGRAMMING ACCURACY<sup>5</sup>

Range	Programming Resolution	Accuracy (1 Year) 23°C ± 5°C ±(% rdg. + amps)	Typical Noise (Peak-Peak) 0.1Hz–10Hz
100 nA	2 pA	0.03% + 100 pA	5 pA
1 μA	20 pA	0.03% + 800 pA	25 pA
10 μA	200 pA	0.03% + 5 nA	60 pA
100 μA	2 nA	0.03% + 60 nA	3 nA
1 mA	20 nA	0.03% + 300 nA	6 nA
10 mA	200 nA	0.03% + 6 μA	200 nA
100 mA	2 μA	0.03% + 30 μA	600 nA
1 A <sup>6</sup>	20 μA	0.05% + 1.8 mA	70 μA
1.5 A <sup>6</sup>	50 μA	0.06% + 4 mA	150 μA
10 A <sup>6,7</sup>	200 μA	0.5% + 40 mA (typical)	

TEMPERATURE COEFFICIENT (0°–18°C and 28°–50°C)<sup>8</sup>: ±(0.15 × accuracy specification) %/°C. Applicable for normal mode only. Not applicable for high capacitance mode.

MAXIMUM OUTPUT POWER AND SOURCE/SINK LIMITS<sup>3</sup>: 30.3W per channel maximum. ±1.515A @ ±20V, ±101mA @ ±200V, four quadrant source or sink operation.

CURRENT REGULATION: Line: 0.01% of range. Load: ±(0.01% of range + 100pA).

VOLTAGE LIMIT/COMPLIANCE<sup>9</sup>: Bipolar voltage limit (compliance) set with a single value. Minimum value is 20mV. Accuracy is the same as voltage source.

OVERSHOOT: <±0.1% (typical). Step size = 10% to 90% of range, resistive load; see Current Source Output Settling Time for additional test conditions.

### ADDITIONAL SOURCE SPECIFICATIONS

TRANSIENT RESPONSE TIME: <70μs for the output to recover to within 0.1% for a 10% to 90% step change in load.

VOLTAGE SOURCE OUTPUT SETTLING TIME: Time required to within reach 0.1% of final value after source level command is processed on a fixed range.

Range	Settling Time
200 mV	<50 μs (typical)
2 V	<50 μs (typical)
20 V	<110 μs (typical)
200 V	<700 μs (typical)

CURRENT SOURCE OUTPUT SETTLING TIME: Time required to reach within 0.1% of final value after source level command is processed on a fixed range. Values below are at  $R_{load} = 2V$  unless noted.

Current Range	Settling Time
1.5 A – 1 A	<120 μs (typical) ( $R_{load} > 6\Omega$ )
100 mA – 10 mA	<80 μs (typical)
1 mA	<100 μs (typical)
100 μA	<150 μs (typical)
10 μA	<500 μs (typical)
1 μA	<2 ms (typical)
100 nA	<20 ms (typical)

DC FLOATING VOLTAGE: Output can float up to ±250VDC from chassis ground.

REMOTE SENSE OPERATING RANGE: Maximum voltage between HI and SENSE HI = 3V. Maximum voltage between LO and SENSE LO = 3V.

VOLTAGE OUTPUT HEADROOM:

200V Range: Max. output voltage = 202.3V – total voltage drop across source leads (maximum 1Ω per source lead).

20V Range: Max. output voltage = 23.3V – total voltage drop across source leads (maximum 1Ω per source lead).

OVERTEMPERATURE PROTECTION: Internally sensed temperature overload puts unit in standby mode.

VOLTAGE SOURCE RANGE CHANGE OVERSHOOT: <300mV + 0.1% of larger range (typical). Overshoot into a 200kΩ load, 20MHz BW.

CURRENT SOURCE RANGE CHANGE OVERSHOOT: <5% of larger range + 300mV/ $R_{load}$  (typical) – With source settling set to SETTLE\_SMOOTH\_100NA. See Current Source Output Settling Time for additional test conditions.

### NOTES

- Add 50μV to source accuracy specifications per volt of HI lead drop.
- High Capacitance Mode accuracy is applicable at 23°C ± 5°C only.
- Full power source operation regardless of load to 30°C ambient. Above 30°C and/or power sink operation, refer to "Operating Boundaries" in the Series 2600B Reference Manual for additional power derating information.
- For sink mode operation (quadrants II and IV), add 0.06% of limit range to the corresponding current limit accuracy specifications. Specifications apply with sink mode operation enabled.
- Accuracy specifications do not include connector leakage. Derate accuracy by  $V_{out}/2E11 + (0.15V_{out}/2E11)$  per °C when operating between 18°–28°C. Derate accuracy by  $V_{out}/2E11 + (0.15V_{out}/2E11)$  per °C when operating <18°C and >28°C.
- Full power source operation regardless of load to 30°C ambient. Above 30°C and/or power sink operation, refer to "Operating Boundaries" in the Series 2600B Reference Manual for additional power derating information.
- 10A range accessible only in pulse mode.
- High Capacitance Mode accuracy is applicable at 23°C ± 5°C only.
- Full power source operation regardless of load to 30°C ambient. Above 30°C and/or power sink operation, refer to "Operating Boundaries" in the Series 2600B Reference Manual for additional power derating information.
- For sink mode operation (quadrants II and IV), add 10% of compliance range and ±0.02% of limit setting to corresponding voltage source specification. For 200mV range add an additional 120mV of uncertainty.
- Add 50μV to source accuracy specifications per volt of HI lead drop.

### PULSE SPECIFICATIONS

Region	Maximum Current Limit	Maximum Pulse Width <sup>12</sup>	Maximum Duty Cycle <sup>13</sup>
1	100 mA @ 200 V	DC, no limit	100%
1	1.5 A @ 20 V	DC, no limit	100%
2	1 A @ 180 V	8.5 ms	1%
3 <sup>14</sup>	1 A @ 200 V	2.2 ms	1%
4	10 A @ 5 V	1 ms	2.2%

MINIMUM PROGRAMMABLE PULSE WIDTH<sup>15, 16</sup>: 100μs. NOTE: Minimum pulse width for settled source at a given I/V output and load can be longer than 100μs.

PULSE WIDTH PROGRAMMING RESOLUTION: 1μs.

PULSE WIDTH PROGRAMMING ACCURACY<sup>16</sup>: ±5μs.

PULSE WIDTH JITTER: 2μs (typical).

1.888.KEITHLEY (U.S. only)

www.keithley.com

KEITHLEY

A GREATER MEASURE OF CONFIDENCE



# 2611B, 2612B, 2614B

# System SourceMeter® SMU (Source-Measure Unit) Instruments

## SOURCE SPECIFICATIONS (continued)

### PULSE SPECIFICATIONS (continued)

QUADRANT DIAGRAM:

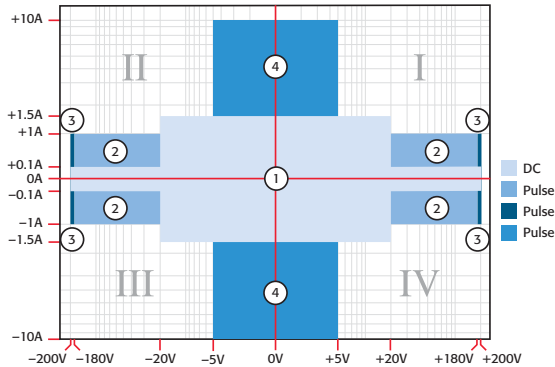

### NOTES

12. Times measured from the start of pulse to the start of off-time; see figure below.

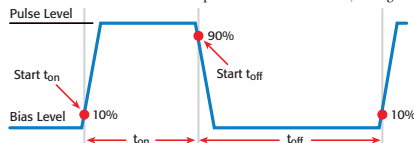

13. Thermally limited in sink mode (quadrants II and IV) and ambient temperatures above 30°C. See power equations in the reference manual for more information.

14. Voltage source operation with 1.5 A current limit.

15. Typical performance for minimum settled pulse widths:

Source Value	Load	Source Settling (% of range)	Minimum Settled Pulse Width
5 V	0.5 Ω	1%	250 μs
20 V	200 Ω	0.2%	200 μs
180 V	180 Ω	0.2%	5 ms
200 V (1.5 A Limit)	200 Ω	0.2%	1.5 ms
100 mA	200 Ω	1%	200 μs
1 A	200 Ω	1%	500 μs
1 A	180 Ω	1%	5 ms
10 A	0.5 Ω	0.5%	300 μs

Typical tests were performed using remote operator software and best, fixed measurement range. For more information on pulse scripts, see the Series 2600B Reference Manual.

16. Times measured from the start of pulse to the start of off-time; see figure below.

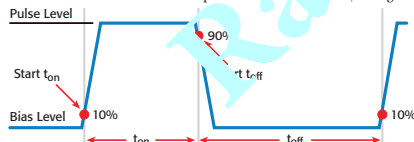

## METER SPECIFICATIONS

### VOLTAGE MEASUREMENT ACCURACY<sup>17, 18</sup>

Range	Default Display Resolution <sup>19</sup>	Input Resistance	Accuracy (1 Year) 23°C ±5°C ±(% rdg. + volts)
200 mV	100 nV	>10 GΩ	0.015% + 225 μV
2 V	1 μV	>10 GΩ	0.02% + 350 μV
20 V	10 μV	>10 GΩ	0.015% + 5 mV
200 V	100 μV	>10 GΩ	0.015% + 50 mV

TEMPERATURE COEFFICIENT (0°–18°C and 28°–50°C): ±(0.5 × accuracy specification)/°C. Applicable for normal mode only. Not applicable for high capacitance mode.

### CURRENT MEASUREMENT ACCURACY<sup>18, 21</sup>

Range	Default Display Resolution <sup>22</sup>	Voltage Burden <sup>23</sup>	Accuracy (1 Year) 23°C ±5°C ±(% rdg. + amps)
100 nA	100 fA	<1 mV	0.06% + 100 pA
1 μA	100 nA	<1 mV	0.025% + 500 pA
10 μA	100 nA	<1 mV	0.025% + 1.5 nA
100 μA	100 nA	<1 mV	0.02% + 25 nA
1 mA	1 nA	<1 mV	0.02% + 200 nA
10 mA	10 nA	<1 mV	0.02% + 2.5 μA
100 mA	100 nA	<1 mV	0.02% + 20 μA
1 A	1 μA	<1 mV	0.03% + 1.5 mA
10 A	10 μA	<1 mV	0.05% + 3.5 mA
10 A <sup>24</sup>	10 μA	<1 mV	0.4% + 25 mA (typical)

CURRENT MEASURE SETTLING TIME (Time for measurement to settle after a Vstep)<sup>25</sup>: Time required to reach 0.1% of final value after source level command is processed on a fixed range. Settling times for V<sub>out</sub> = 2V unless noted. Current Range: 1mA. Settling Time: <100μs (typical).

TEMPERATURE COEFFICIENT (0°–18°C and 28°–50°C)<sup>26</sup>: ±(0.15 × accuracy specification)/°C. Applicable for normal mode only. Not applicable for high capacitance mode.

### CONTACT CHECK<sup>27</sup> (not available on Model 2614B)

Speed	Maximum Measurement Time to Memory For 60Hz (50Hz)	Accuracy (1 Year) 23°C ±5°C ±(%rdg. + ohms)
FAST	1 (1.2) ms	5% + 10 Ω
MEDIUM	4 (5) ms	5% + 1 Ω
SLOW	36 (42) ms	5% + 0.3 Ω

### ADDITIONAL METER SPECIFICATIONS

MAXIMUM LOAD IMPEDANCE:

Normal Mode: 10nF (typical). High Capacitance Mode: 50μF (typical).

COMMON MODE VOLTAGE: 250VDC.

COMMON MODE ISOLATION: >1GΩ, <4500pF.

OVERRANGE: 101% of source range, 102% of measure range.

MAXIMUM SENSE LEAD RESISTANCE: 1kΩ for rated accuracy.

SENSE INPUT IMPEDANCE: >10GΩ.

1.888.KEITHLEY (U.S. only)

www.keithley.com

KEITHLEY

A GREATER MEASURE OF CONFIDENCE

# 2611B, 2612B, 2614B

# System SourceMeter® SMU (Source-Measure Unit) Instruments

## METER SPECIFICATIONS (continued)

### NOTES

- Add 50µV to source accuracy specifications per volt of HI lead drop.
- De-rate accuracy specifications for NPLC setting <1 by increasing error term. Add appropriate % of range term using table below.

NPLC Setting	200mV Range	2V–200V Ranges	100nA Range	1µA–100mA Ranges	1A–1.5A Ranges
0.1	0.01%	0.01%	0.01%	0.01%	0.01%
0.01	0.08%	0.07%	0.1%	0.05%	0.05%
0.001	0.8%	0.6%	1%	0.5%	1.1%

- Applies when in single channel display mode.
- High Capacitance Mode accuracy is applicable at 23°C ±5°C only.
- Accuracy specifications do not include connector leakage. De-rate accuracy by  $V_{out}/2E11$  per °C when operating between 18°–28°C. De-rate accuracy by  $V_{out}/2E11 + (0.15 * V_{out}/2E11)$  per °C when operating <18° and >28°C.
- Applies when in single channel display mode.
- Four-wire remote sense only and with current meter mode selected. Voltage measure set to 200mV or 2V range only.
- 10A range accessible only in pulse mode.
- Compliance equal to 100mA.
- High Capacitance Mode accuracy is applicable at 23°C ±5°C only.
- Includes measurement of SENSE HI to HI and SENSE LO to LO contact resistances.

## HIGH CAPACITANCE MODE 28, 29, 30

**VOLTAGE SOURCE OUTPUT SETTLING TIME:** Time required to reach within 0.1% of final value after source level command is processed on a fixed range. Current limit = 1A.

Voltage Source Range	Settling Time with $C_{load} = 4.7\mu F$
200 mV	600 µs (typical)
2 V	600 µs (typical)
20 V	1.5 ms (typical)
200 V	20 ms (typical)

**CURRENT MEASURE SETTLING TIME:** Time required to reach within 0.1% of final value after voltage source is stabilized on a fixed range. Values below for  $V_{out} = 2V$  unless noted.

Current Measure Range	Settling Time
1.5 A – 1 A	<120 µs (typical) ( $R_{load} > 6\Omega$ )
100 mA – 10 mA	<100 µs (typical)
1 mA	< 3 ms (typical)
100 µA	< 3 ms (typical)
10 µA	< 230 ms (typical)
1 µA	< 230 ms (typical)

**CAPACITOR LEAKAGE PERFORMANCE USING HIGH-C SCRIPTS:**  $I_{leak} = 100nA$  @ 10MΩ.  
Test: 5V step and measure. 200ms (typical) @ 50nA.

### MODE CHANGE DELAY:

- 100µA Current Range and Above:**  
 Delay into High Capacitance Mode: 10ms  
 Delay out of High Capacitance Mode: 10ms.
- 1µA and 10µA Current Ranges:**  
 Delay into High Capacitance Mode: 230ms.  
 Delay out of High Capacitance Mode: 10ms.

**VOLTMETER INPUT IMPEDANCE:** 10MΩ in parallel with 3300pF.

**NOISE, 10Hz–20MHz (20V Range):** < 50mV peak-peak (typical).

**VOLTAGE SOURCE RANGE CHANGE OVERSHOOT (for 20V range and below):** <400mV + 0.1% of larger range (typical). Overshoot to a 200kΩ load, 20MHz BW.

### NOTES

- High Capacitance Mode specifications are for DC measurements only.
- 100nA range is not available in High Capacitance Mode.
- High Capacitance Mode utilizes locked ranges. Auto Range is disabled.
- Part of KI Factory scripts. See reference manual for details.

**SEE PAGES 14 AND 15 FOR MEASUREMENT SPEEDS AND OTHER SPECIFICATIONS.**

## GENERAL

**IEEE-488:** IEEE-488.1 compliant. Supports IEEE-488.2 common commands and status model topology.

**USB CONTROL (REAR):** USB 2.0 device, TMC488 protocol.

**RS-232:** Baud rates from 300bps to 115200bps.

**ETHERNET:** RJ-45 connector, LXI Class C, 10/100BT, no auto MDIX.

**EXPANSION INTERFACE:** The TSP-Link expansion interface allows TSP enabled instruments to trigger and communicate with each other. (Not available on Model 2614B)

**Cable Type:** Category 5e or higher LAN crossover cable.

**Length:** 3 meters maximum between each TSP enabled instrument.

**LXI COMPLIANCE:** LXI Class C 1.4.

**LXI TIMING: Total Output Trigger Response Time:** 70µs min., 280µs typ., (not specified) max. **Receive LAN[0-7] Event Delay:** Undefined. **Generate LAN[0-7] Event Delay:** Unknown.

**DIGITAL I/O INTERFACE:** (Not available on Model 2614B)

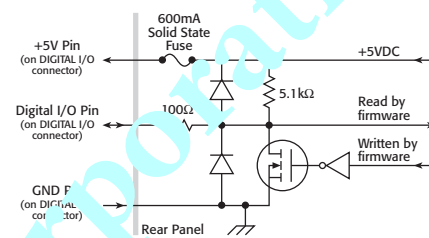

**Connector:** 25-pin female D.

**Input/Output Pins:** 14 open drain I/O bits.

**Absolute Maximum Input Voltage:** 5.25V.

**Absolute Minimum Input Voltage:** -0.25V.

**Maximum Logic Low Input Voltage:** 0.7V, +850µA max.

**Minimum Logic High Input Voltage:** 2.1V, +570µA.

**Maximum Source Current (flowing out of Digital I/O bit):** +960µA.

**Maximum Sink Current @ Maximum Logic Low Voltage (0.7V):** -5.0mA.

**Absolute Maximum Sink Current (flowing into Digital I/O pin):** -11mA.

**5V Power Supply Pin:** Limited to 600mA, solid state fuse protected.

**Safety Interlock Pin:** Active high input. >3.4V @ 24mA (absolute maximum of 6V) must be externally applied to this pin to ensure 200V operation. This signal is pulled down to chassis ground with a 10kΩ resistor. 200V operation will be blocked when the INTERLOCK signal is <0.4V (absolute minimum -0.4V). See figure below:

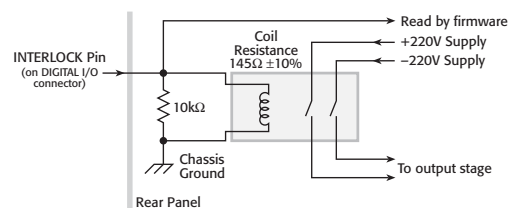

**USB FILE SYSTEM (FRONT):** USB 2.0 Host: Mass storage class device.

**POWER SUPPLY:** 100V to 250VAC, 50–60Hz (auto sensing), 240VA max.

**COOLING:** Forced air. Side intake and rear exhaust. One side must be unobstructed when rack mounted.

**EMC:** Conforms to European Union Directive 2004/108/EEC, EN 61326-1.

**SAFETY:** Conforms to European Union Directive 73/23/EEC, EN 61010-1, and UL 61010-1.

**DIMENSIONS:** 89mm high × 213mm wide × 460mm deep (3½ in × 8½ in × 17½ in). Bench Configuration (with handle and feet): 104mm high × 238mm wide × 460mm deep (4½ in × 9½ in × 17½ in).

**WEIGHT:** 2611B: 4.75kg (10.4 lbs). 2612B, 2614B: 5.50kg (12.0 lbs).

**ENVIRONMENT:** For indoor use only. **Altitude:** Maximum 2000 meters above sea level.

**Operating:** 0°–50°C, 70% R.H. up to 35°C. De-rate 3% R.H./°C, 35°–50°C.

**Storage:** -25°C to 65°C.

# 2634B, 2635B, 2636B

# System SourceMeter® SMU (Source-Measure Unit) Instruments

## SPECIFICATION CONDITIONS

This document contains specifications and supplemental information for the Models 2634B, 2635B, and 2636B System SourceMeter® instruments. Specifications are the standards against which the Models 2634B, 2635B, and 2636B are tested. Upon leaving the factory the 2634B, 2635B, and 2636B meet these specifications. Supplemental and typical values are non-warranted, apply at 23°C, and are provided solely as useful information.

Accuracy specifications are applicable for both normal and high capacitance modes. The source and measurement accuracies are specified at the SourceMeter CHANNEL A (2634B, 2635B, and 2636B) or SourceMeter CHANNEL B (2634B, 2636B) terminals under the following conditions:

1. 23°C ± 5°C, <70% relative humidity.
2. After 2 hour warm-up
3. Speed normal (1 NPLC)
4. A/D auto-zero enabled
5. Remote sense operation or properly zeroed local sense operation
6. Calibration period = 1 year

## SOURCE SPECIFICATIONS

### VOLTAGE SOURCE SPECIFICATIONS

#### VOLTAGE PROGRAMMING ACCURACY<sup>1</sup>

Range	Programming Resolution	Accuracy (1 Year) 23°C ± 5°C ±(% rdg. + volts)	Typical Noise (peak-peak) 0.1Hz–10Hz
200 mV	5 μV	0.02% + 375 μV	20 μV
2 V	50 μV	0.02% + 600 μV	50 μV
20 V	500 μV	0.02% + 5 mV	300 μV
200 V	5 mV	0.02% + 50 mV	2 mV

TEMPERATURE COEFFICIENT (0°–18°C and 28°–50°C)<sup>2</sup>: ±(0.15 × accuracy specification)/°C. Applicable for normal mode only. Not applicable for high capacitance mode.

MAXIMUM OUTPUT POWER AND SOURCE/SINK LIMITS<sup>3</sup>: 30.3W per channel maximum. ±20.2V @ ±1.5A, ±202V @ ±100mA, four quadrant source or sink operation.

VOLTAGE REGULATION: Line: 0.01% of range. Load: ±(0.01% of range + 100μV).

NOISE 10Hz–20MHz: <20mV pk-pk (typical), <3mV rms (typical), 20V range.

CURRENT LIMIT/COMPLIANCE<sup>4</sup>: Bipolar current limit (compliance) set with single value. Minimum value is 100pA. Accuracy is the same as current source.

OVERSHOOT: <±(0.1% + 10mV) typical (step size = 10% to 90% of range resistive load, maximum current limit/compliance).

GUARD OFFSET VOLTAGE: <4mV (current <10mA).

### CURRENT SOURCE SPECIFICATIONS

#### CURRENT PROGRAMMING ACCURACY<sup>1</sup>

Range	Programming Resolution	Accuracy (1 Year) 23°C ± 5°C ±(% rdg. + amps)	Typical Noise (peak-peak) 0.1Hz–10Hz
1 nA	20 fA	0.01% + 2 pA	800 fA
10 nA	200 fA	0.01% + 5 pA	2 pA
100 nA	2 pA	0.01% + 50 pA	5 pA
1 μA	20 pA	0.03% + 700 pA	25 pA
10 μA	200 pA	0.03% + 5 nA	60 pA
100 μA	2 nA	0.03% + 60 nA	3 nA
1 mA	20 nA	0.03% + 300 nA	6 nA
10 mA	200 nA	0.03% + 6 μA	200 nA
100 mA	2 μA	0.03% + 30 μA	600 nA
1 A <sup>5</sup>	20 μA	0.05% + 1.8 mA	70 μA
1.5 A <sup>5</sup>	50 μA	0.06% + 4 mA	150 μA
10 A <sup>5,6</sup>	200 μA	0.5 % + 40 mA (typical)	

TEMPERATURE COEFFICIENT (0°–18°C and 28°–50°C)<sup>2</sup>: ±(0.15 × accuracy specification)/°C. Applicable for normal mode only. Not applicable for high capacitance mode.

MAXIMUM OUTPUT POWER AND SOURCE/SINK LIMITS<sup>3</sup>: 30.3W per channel maximum. ±1.515A @ ±20V, ±101mA @ ±200V, four quadrant source or sink operation.

CURRENT REGULATION: Line: 0.01% of range. Load: ±(0.01% of range + 100pA).

VOLTAGE LIMIT/COMPLIANCE<sup>4</sup>: Bipolar voltage limit (compliance) set with a single value. Minimum value is 20mV. Accuracy is the same as voltage source.

OVERSHOOT: <±0.1% typical (step size = 10% to 90% of range, resistive load, maximum current limit/compliance; see Current Source Output Settling Time for additional test conditions).

## ADDITIONAL SOURCE SPECIFICATIONS

TRANSIENT RESPONSE TIME: <70μs for the output to recover to within 0.1% for a 10% to 90% step change in load.

VOLTAGE SOURCE OUTPUT SETTLING TIME: Time required to reach within 0.1% of final value after source level command is processed on a fixed range.

Range	Settling Time
200 mV	<50 μs (typical)
2 V	<50 μs (typical)
20 V	<110 μs (typical)
200 V	<700 μs (typical)

CURRENT SOURCE OUTPUT SETTLING TIME: Time required to reach within 0.1% of final value after source level command is processed on a fixed range. Value below 100mA:  $t_{settle} \propto R_{load}$  unless noted.

Current Range	Settling Time
1.5 A – 1 A	<120 μs (typical) ( $R_{load} > 5\Omega$ )
100 mA – 10 mA	<80 μs (typical)
1 mA	<100 μs (typical)
100 μA	<150 μs (typical)
10 μA	<500 μs (typical)
1 μA	<2 ms (typical)
100 nA	<20 ms (typical)
10 nA	<40 ms (typical)
1 nA	<100 ms (typical)

DC FLOATING VOLTAGE: Output can be floated up to ±250VDC.

REMOTE SENSE OPERATING RANGE<sup>10</sup>: Maximum voltage between HI and SENSE HI = 3V. Maximum voltage between LO and SENSE LO = 3V.

VOLTAGE OUTPUT RANGE<sup>10</sup>: ROOM:

200V Range: Maximum output voltage = 202.3V – total voltage drop across source leads (maximum 10mV per source lead).

20V Range: Maximum output voltage = 23.3V – total voltage drop across source leads (maximum 1mV per source lead).

OVERTEMPERATURE PROTECTION: Internally sensed temperature overload puts unit in standby mode.

VOLTAGE SOURCE RANGE CHANGE OVERSHOOT: <300mV + 0.1% of larger range (typical). Overshoot into a 200kΩ load, 20MHz BW.

CURRENT SOURCE RANGE CHANGE OVERSHOOT: <5% of larger range + 300mV/ $R_{load}$  (typical) – With source settling set to SETTLE\_SMOOTH\_100NA. See Current Source Output Settling Time for additional test conditions.

## PULSE SPECIFICATIONS

Region	Maximum Current Limit	Maximum Pulse Width <sup>11</sup>	Maximum Duty Cycle <sup>12</sup>
1	100 mA @ 200 V	DC, no limit	100%
1	1.5 A @ 20 V	DC, no limit	100%
2	1 A @ 180 V	8.5 ms	1%
3 <sup>13</sup>	1 A @ 200 V	2.2 ms	1%
4	10 A @ 5 V	1 ms	2.2%

MINIMUM PROGRAMMABLE PULSE WIDTH<sup>14, 15</sup>: 100μs. NOTE: Minimum pulse width for settled source at a given I/V output and load can be longer than 100μs.

PULSE WIDTH PROGRAMMING RESOLUTION: 1μs.

PULSE WIDTH PROGRAMMING ACCURACY<sup>15</sup>: ±5μs.

PULSE WIDTH JITTER: 50μs (typical).

QUADRANT DIAGRAM:

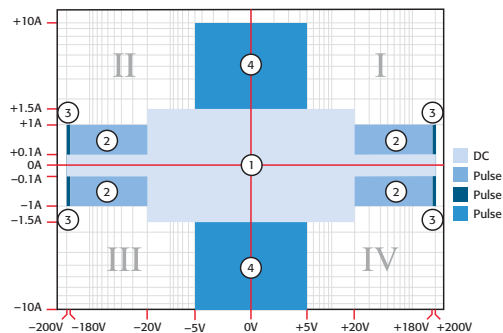

Series 2600B specifications

SMU INSTRUMENTS

**1.888.KEITHLEY (U.S. only)**  
**www.keithley.com**



A GREATER MEASURE OF CONFIDENCE

# 2634B, 2635B, 2636B

# System SourceMeter® SMU (Source-Measure Unit) Instruments

## SOURCE SPECIFICATIONS (continued)

### NOTES

1. Add 50µV to source accuracy specifications per volt of HI lead drop.
2. High Capacitance Mode accuracy is applicable at 23°C ±5°C only.
3. Full power source operation regardless of load to 30°C ambient. Above 30°C and/or power sink operation, refer to "Operating Boundaries" in the Series 2600B Reference Manual for additional power derating information.
4. For sink mode operation (quadrants II and IV), add 0.06% of limit range to the corresponding current limit accuracy specifications. Specifications apply with sink mode operation enabled.
5. Full power source operation regardless of load to 30°C ambient. Above 30°C and/or power sink operation, refer to "Operating Boundaries" in the Series 2600B Reference Manual for additional power derating information.
6. 10A range accessible only in pulse mode.
7. High Capacitance Mode accuracy is applicable at 23°C ±5°C only.
8. Full power source operation regardless of load to 30°C ambient. Above 30°C and/or power sink operation, refer to "Operating Boundaries" in the Series 2600B Reference Manual for additional power derating information.
9. For sink mode operation (quadrants II and IV), add 10% of compliance range and ±0.02% of limit setting to corresponding voltage source specification. For 200mV range add an additional 120mV of uncertainty.
10. Add 50µV to source accuracy specifications per volt of HI lead drop.
11. Times measured from the start of pulse to the start off-time; see figure below.

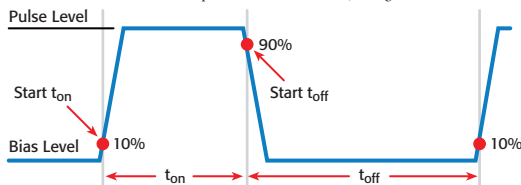

12. Thermally limited in sink mode (quadrants II and IV) and ambient temperatures above 30°C. See power equations in the Reference Manual for more information.
13. Voltage source operation with 1.5 A current limit.
14. Typical performance for minimum settled pulse widths:

Source Value	Load	Source Settling (% of range)	Min. Pulse Width
5 V	0.5 Ω	1%	300 µs
20 V	200 Ω	0.2%	200 µs
180 V	180 Ω	0.2%	5 ms
200 V (1.5 A Limit)	200 Ω	0.2%	5 ms
100 mA	200 Ω	1%	200 µs
1 A	200 Ω	1%	200 µs
1 A	180 Ω	0.2%	5 ms
10 A	0.5 Ω	0.5%	300 µs

Typical tests were performed using remote operation, 4W sense, and best, fixed measurement range. For more information on pulse scripts, see the Series 2600B Reference Manual.

15. Times measured from the start of pulse to the start off-time; see figure below.

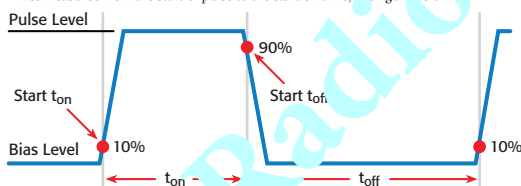

## METER SPECIFICATIONS

### VOLTAGE MEASUREMENT ACCURACY<sup>16, 17</sup>

Range	Default Display Resolution <sup>18</sup>	Input Resistance	Accuracy (1 Year) 23°C ±5°C ±(% rdg. + volts)
200 mV	100 nV	>10 <sup>14</sup> Ω	0.015% + 225 µV
2 V	1 µV	>10 <sup>14</sup> Ω	0.02% + 350 µV
20 V	10 µV	>10 <sup>14</sup> Ω	0.015% + 5 mV
200 V	100 µV	>10 <sup>14</sup> Ω	0.015% + 50 mV

TEMPERATURE COEFFICIENT (0°–18°C and 28°–50°C)<sup>19</sup>: ±(0.1 × accuracy specification)/°C. Applicable for normal mode only. Not applicable for high capacitance mode.

### CURRENT MEASUREMENT ACCURACY<sup>20, 21</sup>

Range	Default Display Resolution <sup>20</sup>	Voltage Burden <sup>21</sup>	Accuracy (1 Year) 23°C ±5°C ±(% rdg. + amps)
100 pA <sup>22, 23</sup>	0.1 fA	<1 mV	0.15% + 120 fA
1 nA <sup>22, 24</sup>	100 pA	<1 mV	0.15% + 240 fA
10 nA	10 pA	<1 mV	0.15% + 3 pA
100 nA	100 fA	<1 mV	0.06% + 40 pA
1 µA	1 pA	<1 mV	0.025% + 400 pA
10 µA	10 pA	<1 mV	0.025% + 1.5 nA
100 µA	100 pA	<1 mV	0.02% + 25 nA
1 mA	1 nA	<1 mV	0.02% + 200 nA
10 mA	10 nA	<1 mV	0.02% + 2.5 µA
100 mA	100 nA	<1 mV	0.02% + 20 µA
1 A	1 µA	<1 mV	0.03% + 15 mA
1.5 A	1 µA	<1 mV	0.05% + 3.5 mA
10 A <sup>25</sup>	10 µA	<1 mV	0.4% + 25 mA

CURRENT MEASURE SETTLING TIME (Time for measurement to settle after a Vstep)<sup>26</sup>: Time required to reach within 0.1% of final value after source level command is processed on a fixed range. Values for V<sub>out</sub> = 2V unless noted. **Current Range:** 1mA. **Settling Time:** <100µs (typical).

TEMPERATURE COEFFICIENT (0°–18°C and 28°–50°C)<sup>27</sup>: ±(0.15 × accuracy specification)/°C. Applicable for normal mode only. Not applicable for high capacitance mode.

### CONTACT CHECK<sup>28</sup> (Not available on Model 2634B)

Speed	Maximum Measurement Time to Memory For 60Hz (50Hz)	Accuracy (1 Year) 23°C ±5°C ±(%rdg. + ohms)
FAST	1 (1.2) ms	5% + 10 Ω
MEDIUM	4 (5) ms	5% + 1 Ω
SLOW	36 (42) ms	5% + 0.3 Ω

### ADDITIONAL METER SPECIFICATIONS

#### MAXIMUM LOAD IMPEDANCE:

Normal Mode: 10nF (typical). High Capacitance Mode: 50µF (typical).

COMMON MODE VOLTAGE: 250VDC.

COMMON MODE ISOLATION: >1GΩ, <4500pF.

OVERRANGE: 101% of source range, 102% of measure range.

MAXIMUM SENSE LEAD RESISTANCE: 1kΩ for rated accuracy.

SENSE INPUT IMPEDANCE: >10<sup>14</sup>Ω.

# 2634B, 2635B, 2636B

# System SourceMeter® SMU (Source-Measure Unit) Instruments

## METER SPECIFICATIONS (continued)

### NOTES

16. Add 50μV to source accuracy specifications per volt of HI lead drop.  
17. De-rate accuracy specifications for NPLC setting <1 by increasing error term. Add appropriate % of range term using table below.

NPLC Setting	200mV Range	2V–200V Ranges	100nA Range	1μA–100mA Ranges	1A–1.5A Ranges
0.1	0.01%	0.01%	0.01%	0.01%	0.01%
0.01	0.08%	0.07%	0.1%	0.05%	0.05%
0.001	0.8 %	0.6 %	1%	0.5 %	1.1 %

18. Applies when in single channel display mode.  
19. High Capacitance Mode accuracy is applicable at 23°C ±5°C only.  
20. Applies when in single channel display mode.  
21. Four-wire remote sense only and with current meter mode selected. Voltage measure set to 200mV or 2V range only.  
22. 10-NPLC, 11-Point Median Filter, <200V range, measurements made within 1 hour after zeroing. 23°C ± 1°C  
23. Under default specification conditions: ±(0.15% + 750fA).  
24. Under default specification conditions: ±(0.15% + 1pA).  
25. 10A range accessible only in pulse mode.  
26. Delay factor set to 1. Compliance equal to 100mA.  
27. High Capacitance Mode accuracy is applicable at 23°C ±5°C only.  
28. Includes measurement of SENSE HI to HI and SENSE LO to LO contact resistances.

## HIGH CAPACITANCE MODE 29, 30, 31

**VOLTAGE SOURCE OUTPUT SETTLING TIME:** Time required to reach within 0.1% of final value after source level command is processed on a fixed range. Current limit = 1A.

Voltage Source Range	Settling Time with $C_{load} = 4.7\mu F$
200 mV	600 μs (typical)
2 V	600 μs (typical)
20 V	1.5 ms (typical)
200 V	20 ms (typical)

**CURRENT MEASURE SETTLING TIME:** Time required to reach within 0.1% of final value after voltage source is stabilized on a fixed range. Values below for  $V_{out} = 2V$  unless noted.

Current Measure Range	Settling Time
1.5 A – 1 A	<120 μs (typical) ( $R_{load} > 6\Omega$ )
100 mA – 10 mA	<100 μs (typical)
1 mA	< 3 ms (typical)
100 μA	< 3 ms (typical)
10 μA	< 230 ms (typical)
1 μA	< 230 ms (typical)

**CAPACITOR LEAKAGE PERFORMANCE USING HIGH-C SCRIPTS 32:**  $C_{leak} = 5\mu F | 10M\Omega$ .  
Test: 5V step and measure. 200ms (typical) @ 50nA.

### MODE CHANGE DELAY:

**100μA Current Range and Above:**

Delay into High Capacitance Mode: 10ms

Delay out of High Capacitance Mode: 10ms

**1μA and 10μA Current Ranges:**

Delay into High Capacitance Mode: 2ms

Delay out of High Capacitance Mode: 10ms

**VOLTMETER INPUT IMPEDANCE:** 90Ω in parallel with 3300pF.

**NOISE, 10Hz–20MHz (20V Range):** <50mV peak-peak (typical).

**VOLTAGE SOURCE RANGE CHANGE OVERSHOOT (for 20V range and below):** <400mV + 0.1% of larger range (typical). Overshoot into a 200kΩ load, 20MHz BW.

### NOTES

29. High Capacitance Mode specifications are for DC measurements only.  
30. 100nA range and below are not available in high capacitance mode.  
31. High Capacitance Mode utilizes locked ranges. Auto Range is disabled.  
32. Part of KI Factory scripts. See reference manual for details.

**SEE PAGES 14 AND 15 FOR MEASUREMENT SPEEDS AND OTHER SPECIFICATIONS.**

**1.888.KEITHLEY (U.S. only)**

**www.keithley.com**

## GENERAL

**IEEE-488:** IEEE-488.1 compliant. Supports IEEE-488.2 common commands and status model topology.

**USB CONTROL (REAR):** USB 2.0 device, TMC488 protocol.

**RS-232:** Baud rates from 300bps to 115200bps. Programmable number of data bits, parity type, and flow control (RTS/CTS hardware or none).

**ETHERNET:** RJ-45 connector, LXI Class C, 10/100BT, no auto MDIX.

**EXPANSION INTERFACE:** The TSP-Link expansion interface allows TSP enabled instruments to trigger and communicate with each other. (Not available on Model 2614B.)

**Cable Type:** Category 5e or higher LAN crossover cable.

**Length:** 3 meters maximum between each TSP enabled instrument.

**LXI COMPLIANCE:** LXI Class C 1.4.

**LXI TIMING: Total Output Trigger Response Time:** 2.5μs min., 280μs typ., (not specified) max. **Receive LAN[0-7] Event Delay:** Unknown. **Generate LAN[0-7] Event Delay:** Unknown.

**DIGITAL I/O INTERFACE: (Not available on Model 2614B)**

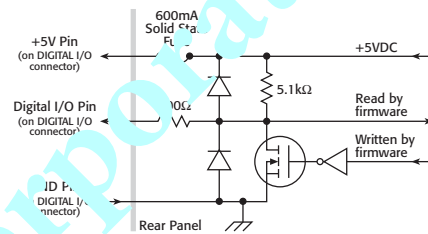

**Connector:** 25-pin female D.

**Input/Output Pins:** 14 open drain I/O bits.

**Absolute Maximum Input Voltage:** 5.25V.

**Absolute Minimum Input Voltage:** -0.25V.

**Maximum Logic Low Input Voltage:** 0.7V, +850μA max.

**Minimum Logic High Input Voltage:** 2.1V, +570μA.

**Maximum Source Current (flowing out of Digital I/O bit):** +960μA.

**Maximum Sink Current @ Maximum Logic Low Voltage (0.7V):** -5.0mA.

**Absolute Maximum Sink Current (flowing into Digital I/O pin):** -11mA.

**5V Power Supply Pin:** Limited to 600mA, solid state fuse protected.

**Safety Interlock Pin:** Active high input. >3.4V @ 24mA (absolute maximum of 6V) must be externally applied to this pin to ensure 200V operation. This signal is pulled down to chassis ground with a 10kΩ resistor. 200V operation will be blocked when the INTERLOCK signal is <0.4V (absolute minimum -0.4V). See figure below:

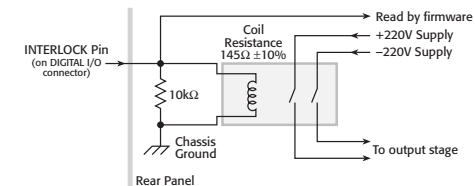

**USB FILE SYSTEM (FRONT):** USB 2.0 Host: Mass storage class device.

**POWER SUPPLY:** 100V to 250VAC, 50–60Hz (auto sensing), 240VA max.

**COOLING:** Forced air. Side intake and rear exhaust. One side must be unobstructed when rack mounted.

**EMC:** Conforms to European Union Directive 2004/108/EEC, EN 61326-1.

**SAFETY:** Conforms to European Union Directive 73/23/EEC, EN 61010-1, and UL 61010-1.

**DIMENSIONS:** 89mm high × 213mm wide × 460mm deep (3½ in × 8½ in × 17½ in). Bench Configuration (with handle and feet): 104mm high × 238mm wide × 460mm deep (4¼ in × 9½ in × 17½ in).

**WEIGHT:** 2635B: 4.75kg (10.4 lbs). 2634B, 2636B: 5.50kg (12.0 lbs).

**ENVIRONMENT:** For indoor use only. **Altitude:** Maximum 2000 meters above sea level.

**Operating:** 0°–50°C, 70% R.H. up to 35°C. Derate 3% R.H./°C, 35°–50°C.

**Storage:** -25°C to 65°C.

# Series 2600B

# System SourceMeter® SMU (Source-Measure Unit) Instruments

Applicable to Models 2601B, 2602B, 2604B, 2611B, 2612B, 2614B, 2634B, 2635B, and 2636B.

## MEASUREMENT SPEED SPECIFICATIONS <sup>1, 2, 3</sup>

### MAXIMUM SWEEP OPERATION RATES (operations per second) FOR 60Hz (50Hz):

A/D Converter Speed	Trigger Origin	Measure To Memory Using User Scripts	Measure To GPIB Using User Scripts	Source Measure To Memory Using User Scripts	Source Measure To GPIB Using User Scripts	Source Measure To Memory Using Sweep API	Source Measure To GPIB Using Sweep API
0.001 NPLC	Internal	20000 (20000)	10500 (10500)	7000 (7000)	6200 (6200)	12000 (12000)	5900 (5900)
0.001 NPLC	Digital I/O	8100 (8100)	7100 (7100)	5500 (5500)	5100 (5100)	11200 (11200)	5700 (5700)
0.01 NPLC	Internal	5000 (4000)	4000 (3500)	3400 (3000)	3200 (2900)	4200 (3700)	3100 (2800)
0.01 NPLC	Digital I/O	3650 (3200)	3400 (3000)	3000 (2700)	2900 (2600)	4150 (3650)	3050 (2775)
0.1 NPLC	Internal	580 (490)	560 (475)	550 (465)	550 (460)	575 (480)	545 (460)
0.1 NPLC	Digital I/O	560 (470)	450 (460)	545 (460)	540 (450)	570 (470)	545 (460)
1.0 NPLC	Internal	59 (49)	59 (49)	59 (49)	59 (49)	59 (49)	59 (49)
1.0 NPLC	Digital I/O	58 (48)	58 (49)	59 (49)	59 (49)	59 (49)	59 (49)

### MAXIMUM SINGLE MEASUREMENT RATES (operations per second) FOR 60Hz (50Hz):

A/D Converter Speed	Trigger Origin	Measure To GPIB	Source Measure To GPIB	Source Measure Pass/Fail To GPIB
0.001 NPLC	Internal	1900 (1800)	1400 (1400)	1400 (1400)
0.01 NPLC	Internal	1450 (1400)	1200 (1100)	1100 (1100)
0.1 NPLC	Internal	450 (390)	425 (370)	425 (375)
1.0 NPLC	Internal	58 (48)	57 (48)	57 (48)

**MAXIMUM MEASUREMENT RANGE CHANGE RATE:** <150µs for ranges >10µA, typical. When changing to or from a range >1A, maximum rate is <450µs, typical.

**MAXIMUM SOURCE RANGE CHANGE RATE:** <2.5ms for ranges >10µA, typical. When changing to or from a range >1A, maximum rate is <5.2ms, typical.

**MAXIMUM SOURCE FUNCTION CHANGE RATE:** <1ms, typical.

**COMMAND PROCESSING TIME:** Maximum time required for the output to begin to change following the receipt of the smux.source.leveln or smux.source.leveln command. <1ms typical.

#### NOTES

1. Tests performed with a 2602B, 2612B, or 2636B on Channel A using the following equipment: PC Hardware (Pentium® 4 2.4GHz, 512MB RAM, National Instruments PCI-GPIB). Driver (NI-486.2 Version 2.2 PCI-GPIB). Software (Microsoft® Windows® 2000, Microsoft Visual Studio 2005, VISA version 4.1).
2. Exclude current measurement ranges less than 1mA.
3. 2635B/2636B with default measurement delays and filters disabled.

### TRIGGERING AND SYNCHRONIZATION SPECIFICATIONS <sup>1</sup>

#### TRIGGERING:

- Trigger in to trigger out: 0.5µs, typical.
- Trigger in to source change:<sup>2</sup> 10µs, typical.
- Trigger Timer accuracy: ±2µs, typical.
- Source change<sup>2</sup> after LXI Trigger: 280µs, typical.

#### SYNCHRONIZATION:

- Single-node synchronized source change:<sup>4</sup> <0.5µs, typical.
- Multi-node synchronized source change:<sup>4</sup> <0.5µs, typical.

#### NOTES

1. TSP-Link not available on Models 2604B, 2614B, and 2634B.
2. Fixed source range, with no polarity change.

# Series 2600B

# System SourceMeter® SMU (Source-Measure Unit) Instruments

Applicable to Models 2601B, 2602B, 2604B, 2611B, 2612B, 2614B, 2634B, 2635B, and 2636B.

## SUPPLEMENTAL INFORMATION

**FRONT PANEL INTERFACE:** Two-line vacuum fluorescent display (VFD) with keypad and rotary knob.

**Display:**

- Show error messages and user defined messages
- Display source and limit settings
- Show current and voltage measurements
- View measurements stored in dedicated reading buffers

**Keypad Operations:**

- Change host interface settings
- Save and restore instrument setups
- Load and run factory and user defined test scripts (i.e. sequences) that prompt for input and send results to the display
- Store measurements into dedicated reading buffers

**PROGRAMMING:** Embedded Test Script Processor (TSP) accessible from any host interface. Responds to individual instrument control commands. Responds to high speed test scripts comprised of instrument control commands and Test Script Language (TSL) statements (e.g. branching, looping, math, etc.). Able to execute high speed test scripts stored in memory without host intervention.

**Minimum Memory Available:** 16MB (approximately 250,000 lines of TSL code).

**Test Script Builder:** Integrated development environment for building, running, and managing TSP scripts. Includes an instrument console for communicating with any TSP enabled instrument in an interactive manner. Requires:

- VISA (NI-VISA included on CD)
- Microsoft .NET Framework (included on CD)
- Keithley I/O Layer (included on CD)
- Pentium III 800MHz or faster personal computer
- Microsoft Windows 98, NT, 2000, or XP

**Software Interface:** TSP Express (embedded), Direct GPIB/VISA, READ/WRITE for VB, VC/C++, LabVIEW, LabWindows/CVI, etc.

**READING BUFFERS:** Dedicated storage area(s) reserved for measurement data. Reading buffers are arrays of measurement elements. Each element can hold the following items:

- Measurement
- Measurement status
- Timestamp
- Source setting (at the time the measurement was taken)
- Range information

Two reading buffers are reserved for each SourceMeter channel. Reading buffers can be filled using the front panel STORE key and retrieved using the RECALL key on the host interface.

**Buffer Size, with timestamp and source setting:** >60,000 samples.

**Buffer Size, without timestamp and source setting:** >140,000 samples.

**SYSTEM EXPANSION:** The TSP-Link expansion interface allows TSP enabled instruments to trigger and communicate with each other. See figure below.

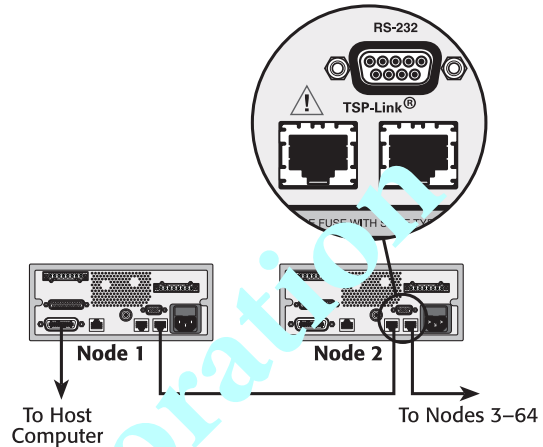

Each SourceMeter instrument has two TSP-Link connectors to facilitate chaining instruments together.

- Or, SourceMeter instruments are interconnected via TSP-Link, a computer can access all the resolutions of each SourceMeter instrument via the host interface of any SourceMeter instrument.

- A maximum of 32 TSP-Link nodes can be interconnected. Each SourceMeter instrument consumes one TSP-Link node.

**TIMER:** Free running 47-bit counter with 1MHz clock input. Reset each time instrument powers up. Rolls over every 4 years.

**Timestamp:** TIMER value automatically saved when each measurement is triggered.

**Resolution:** 1µs.

**Accuracy:** ±100ppm.

## ACCESSORIES AVAILABLE

### CABLES AND CONNECTORS

2600-BAN	Banana Test Lead/Adapter Cable. For a single 2601P, 2602, 2604E, 261B/2612B/2614B source instrument channel.
2600-KIT	Extra screw terminal connector, strain relief, and cover for a single SourceMeter channel (one supplied with 2601B/2611B, two with 2602B/2604B/2612B/2614B).
2600-TRIAX	Triax Adapter. For a single 2601B/2602B/2611B/2612B SMU instrument channel.
7078-TRX*	3-Slot, Low Noise Triax Cable. For use with 2600-TRIAX Adapter.
7078-TRX-GND	3-Slot male triax to BNC adapter (guard removed).
8606	High Performance Modular Probe Kit. For use with 2600B-BAN.

### DIGITAL I/O, TRIGGER LINK, AND TSP-LINK

2600-TLINK	Digital I/O to TLINK Adapter Cable, 1m
CA-126-1	Digital I/O and Trigger Cable, 1.5m
CA-180-3A	CAT5 Crossover Cable for TSP-Link and direct Ethernet connection (two supplied)

### GPIB INTERFACES AND CABLES

7007-1	Double Shielded GPIB Cable, 1m (3.3 ft.)
7007-2	Double Shielded GPIB Cable, 2m (6.6 ft.)
KPCI-488LPA	IEEE-488 Interface/Controller for the PCI Bus

### SWITCHING

Series 3700	DMM/Switch Systems
707B	Semiconductor Switching Matrix Mainframe

### RACK MOUNT KITS

4299-1	Single Rack Mount Kit with front and rear support
4299-2	Dual Rack Mount Kit with front and rear support
4299-5	1U Vent Panel

### SOFTWARE

ACS-BASIC	Component Characterization Software
-----------	-------------------------------------

### EXTENDED WARRANTIES

2601B-EW	1 Year Extended Warranty for Model 2601B
2602B-EW	1 Year Extended Warranty for Model 2602B
2604B-EW	1 Year Extended Warranty for Model 2604B
2611B-EW	1 Year Extended Warranty for Model 2611B
2612B-EW	1 Year Extended Warranty for Model 2612B
2614B-EW	1 Year Extended Warranty for Model 2614B
2634B-EW	1 Year Extended Warranty for Model 2634B
2635B-EW	1 Year Extended Warranty for Model 2635B
2636B-EW	1 Year Extended Warranty for Model 2636B

### CALIBRATION AND VERIFICATION

2600-STD-RES	Calibration Standard 1GΩ Resistor for Models 2634B, 2635B, and 2636B
--------------	--

Series 2600B specifications

SMU INSTRUMENTS

**1.888.KEITHLEY (U.S. only)**  
**www.keithley.com**



A GREATER MEASURE OF CONFIDENCE

**Series 2600B****System SourceMeter® SMU  
(Source-Measure Unit) Instruments**

Specifications are subject to change without notice. All Keithley trademarks and trade names are the property of Keithley Instruments, Inc. All other trademarks and trade names are the property of their respective companies.

**KEITHLEY**

A Tektronix Company

A Greater Measure of Confidence

KEITHLEY INSTRUMENTS, INC. ■ 28775 AURORA RD. ■ CLEVELAND, OH 44139-1891 ■ 440-248-0400 ■ Fax: 440-248-6168 ■ 1-888-KEITHLEY ■ www.keithley.com

**BELGIUM**

Sint-Pieters-Leeuw  
Ph: 02-3630040  
Fax: 02-3630064  
info@keithley.nl  
www.keithley.nl

**CHINA**

Beijing  
Ph: 86-10-8447-5556  
Fax: 86-10-8225-5018  
china@keithley.com  
www.keithley.com.cn

**FRANCE**

Les Ulis  
Ph: 01-69868360  
Fax: 01-69868361  
info@keithley.fr  
www.keithley.fr

**GERMANY**

Germering  
Ph: 089-84930740  
Fax: 089-84930734  
info@keithley.de  
www.keithley.de

**INDIA**

Bangalore  
Ph: 080-30792600  
Fax: 080-30792688  
support\_india@keithley.com  
www.keithley.in

**ITALY**

Peschiera Borromeo (Mi)  
Ph: 02-5538421  
Fax: 02-55384228  
info@keithley.it  
www.keithley.it

**JAPAN**

Tokyo  
Ph: 81-3-6714-3070  
Fax: 81-3-6714-3080  
info.jp@keithley.com  
www.keithley.jp

**KOREA**

Seoul  
Ph: 82-2-6917-5000  
Fax: 82-2-6917-5005  
keithley@keithley.co.kr  
www.keithley.co.kr

**MALAYSIA**

Penang  
Ph: 60-4-643-9679  
Fax: 60-4-643-3794  
sea@keithley.com  
www.keithley.com

**NETHERLANDS**

Son  
Ph: 040-2675502  
Fax: 040-2675509  
info@keithley.nl  
www.keithley.nl

**SINGAPORE**

Singapore  
Ph: 01-800-8255-2835  
Fax: 65-6356-4483  
sea@keithley.com  
www.keithley.com.sg

**TAIWAN**

Hsinchu  
Ph: 886-3-572-9077  
Fax: 886-3-572-9031  
info\_tw@keithley.com  
www.keithley.com.tw

**UNITED KINGDOM**

Bracknell  
Ph: 044-1344-392450  
Fax: 044-1344-392457  
info@keithley.co.uk  
www.keithley.co.uk